

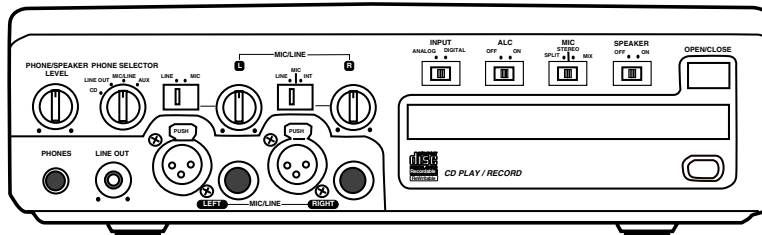

SUPERSCOPE®

PSD300 CD Recording System

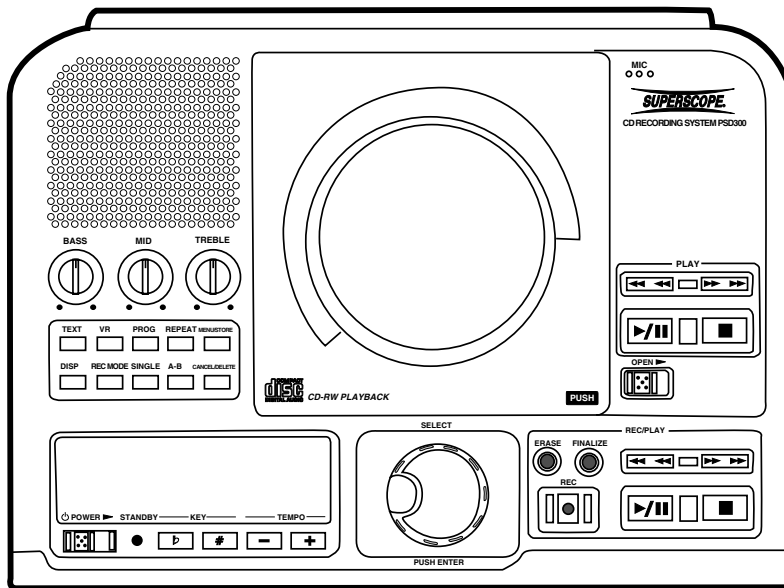
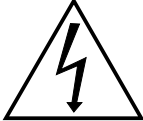

CLASS 1 LASER PRODUCT
LUOKAN 1 LASERLAITE
KALSS 1 LASERAPPARAT

	CAUTION RISK OF ELECTRIC SHOCK DO NOT OPEN	
CAUTION: TO REDUCE THE RISK OF ELECTRIC SHOCK, DO NOT REMOVE COVER (OR BACK) NO USER-SERVICEABLE PARTS INSIDE REFER SERVICING TO QUALIFIED SERVICE PERSONNEL		

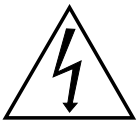

The lightning flash with arrowhead symbol, within an equilateral triangle, is intended to alert the user to the presence of uninsulated "dangerous voltage" within the product's enclosure that may be of sufficient magnitude to constitute a risk of electric shock to persons.



The exclamation point within an equilateral triangle is intended to alert the user to the presence of important operating and maintenance (servicing) instructions in the literature accompanying the appliance.

LASER SAFETY
This unit employs lasers. Only a qualified service person should remove the cover or attempt to service this device, due to possible eye injury.
CAUTION
USE OF CONTROLS OR ADJUSTMENTS OR PERFORMANCE OF PROCEDURE OTHER THAN THOSE SPECIFIED HEREIN MAY RESULT IN HAZARDOUS RADIATION EXPOSURE.

WARNING

TO REDUCE THE RISK OF FIRE OR ELECTRIC SHOCK, DO NOT EXPOSE THIS APPLIANCE TO RAIN OR MOISTURE.

CE marking (only EU version)

 This product is in conformity with the EMC directive and low-voltage directive.

Equipment mains working system

This product complies with household power and safety requirements in your area.

IMPORTANT: (For U.K. only)

This apparatus is fitted with an approved moulded 13 Amp plug. To change a fuse in this type of plug proceed as follows:

- 1 Remove fuse cover and fuse.
- 2 Fix new fuse which should be a BS1362 5A, A.S.T.A. or BSI approved type.
- 3 Refit the fuse cover.

If the fitted plug is not suitable for your socket outlets, it should be cut off and an appropriate plug fitted in its place. If the mains plug contains a fuse, this should have a value of 5A. If a plug without a fuse is used, the fuse at the distribution board should not be greater than 5A.

Note: The severed plug must be destroyed to avoid possible shock hazard should it be inserted into a 13A socket elsewhere.

HOW TO CONNECT A PLUG

The wires in this mains lead are coloured in accordance with the following code:

GREEN-and-YELLOW-"EARTH" ("E")

BLUE-"NEUTRAL" ("N")

BROWN-"LIVE" ("L")

As the colours of the wires in the mains lead of this apparatus may not correspond with the coloured markings identifying the terminals in your plug, proceed as follows:

- 1 The wire which is coloured green-and-yellow must be connected to the terminal in the plug which is marked with the letter "E" or by the earth symbol or coloured green or green-and-yellow.
- 2 The wire which is coloured blue must be connected to the terminal which is marked with the letter "N" or coloured BLACK.
- 3 The wire which is coloured brown must be connected to the terminal which is marked with the letter "L" or coloured RED.

Before replacing the plug cover, make certain that the cord grip is clamped over the sheath of the lead -- not simply over the three wires.

SAFETY INSTRUCTIONS

READ BEFORE OPERATING EQUIPMENT

This product was designed and manufactured to meet strict quality and safety standards. There are, however some installation and operation precautions which you should be particularly aware of.

1. Read Instructions – All the safety and operating instructions should be read before the appliance is operated.
2. Retain Instructions – The safety and operating instructions should be retained for future reference.
3. Heed Warnings – All warnings on the appliance and in the operating instructions should be adhered to.
4. Follow Instructions – All operating and use instructions should be followed.
5. Water and Moisture – The appliance should not be used near water – for example, near a bathtub, washbowl, kitchen sink, laundry tub, in a wet basement, or near a swimming pool, etc. Do not handle with wet hands.
6. Heat – The appliance should be situated away from heat sources such as radiators, heat registers, stoves, or other appliances (including amplifiers) that produce heat or open flames.
7. Cleaning – The appliance should be cleaned only as recommended by the manufacturer.
8. Power sources – The appliance should be connected to a power source only of the type described in the operating instructions or as marked on the appliance.
9. Ground or Polarization – Do not defeat the grounding

or polarization of the appliance, plug or cord.

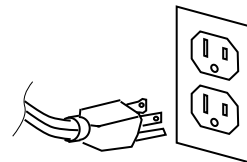

AC polarized plug and receptacle

10. Power Cord – Route power and other cords so they are not likely to be walked on or pinched by items placed on or against them. Pay particular attention to cords at plugs, and receptacles.
11. Non-use Periods – The power cord of the appliance should be unplugged from the outlet when left unused for a long period of time.
12. Object and Liquid Entry – Care should be taken so that objects do not fall and liquids are not spilled into the enclosure through openings. Do not cover this appliance with any cloths, newspapers, curtains, etc.
13. Damage Requiring Service – The appliance should be serviced by qualified service personnel when:
 - A. The power-supply cord or the plug has been damaged; or
 - B. Objects have fallen, or liquid has spilled into the appliance; or
 - C. The appliance has been exposed to rain; or
 - D. The appliance does not appear to operate normally or exhibits a marked change in performance; or
 - E. The appliance has been dropped, or the enclosure damaged.
14. Servicing – The user should not attempt to service the appliance beyond that described in the operating instructions. All other servicing should be referred to qualified service personnel.

NOTE:

This equipment has been tested and found to comply with the limits for a Class B digital device, pursuant to Part 15 of the FCC Rules. These limits are designed to provide reasonable protection against harmful interference in a residential installation. This equipment generates, uses and can radiate radio frequency energy and, if not installed and used in accordance with the instructions, may cause harmful interference to radio communications. However, there is no guarantee that interference will not occur in a particular installation. If this equipment does cause harmful interference to radio or television reception, which can be determined by turning the equipment off and on, the user is

encouraged to try to correct the interference by one or more of the following measures:

- Re-orient or relocate the receiving antenna.
- Increase the separation between the equipment and receiver.
- Connect the equipment into an outlet on a circuit different from that to which the receiver is connected.
- Consult the dealer or an experienced radio/TV technician for help.

NOTE: Changes or modifications may cause this unit to fail to comply with Part 15 of the FCC Rules and may void the user's authority to operate the equipment.

This Class B digital apparatus meets all requirements of the Canadian Interference Causing Equipment Regulations.

Cet appareil numérique de la Class B respecte toutes les exigences du Règlement sur le matériel brouilleur du Canada.

Table of Contents

Topic	page
Warnings	2
Safety Instructions	3
Table of Contents	4
Introduction	5
Drive terminology	5
Package contents	6
Remote batteries	6
Connections (basic).....	6
Controls, Display (top)	
1 Speaker grill	7
2 CD drive	7
3 MIC (microphone)	7
4 Model number	7
5 Tone controls	7
6 Control buttons	
1 TEXT button	7
2 VR button	7
3 PROG button	7
4 REPEAT button	7
5 MENU/STORE button	8
REC menu table	8
6 DISP button	9
7 REC MODE button	9
8 SINGLE button	10
9 A-B button	10
10 CANCEL/DELETE button	10
7 PLAY controls	11
1 Fast backward search button	11
2 Fast forward search button	11
3 Play/Pause button	11
4 Stop button	11
8 Open switch	11
9 Standby POWER switch	11
10 STANDBY light	11
Control of tempo and pitch	11
11 KEY controls	11
12 TEMPO controls	12
TUNING	12
13 Display	12
1 TOC	12
2 Record Indicator	12
3 Pause Indicator	12
4 Play Indicator	12
5 PROG Indicator	12
6 REPEAT Indicator	12
7 DIGITAL Indicator	13
8 Level meter	13
9 CD Indicator	13
10 TEXT Indicator	13
11 A-B Indicator	13
12 TOTAL TRACK Indicator	13
13 AUTO Indicator	13
14 SYNC Indicator	13

Topic	page
14 Alphanumeric display	13
14 SELECT control	13
15 REC/PLAY controls	13
1 ERASE button light	14
2 FINALIZE button light	14
3 REC button light	14
4 CDR drive PLAY controls (see page 11) ...	14
Controls, Connections (front)	
1 PHONE/SPEAKER LEVEL control	14
2 PHONE SELECTOR	14
3 MIC/LINE/INT controls and input jacks	14
1 Left XLR or 1/4" input jack	15
2 Right XLR or 1/4" input jack	15
3 Left LINE MIC switch	15
4 Left level control	15
5 Right LINE MIC INT switch	15
6 Right level control	15
4 INPUT ANALOG/DIGITAL switch	15
5 ALC OFF/ON switch	16
6 MIC SPLIT/STEREO/MIX switch	16
7 SPEAKER OFF/ON switch	16
8 OPEN/CLOSE switch	16
9 PHONES jack	16
10 LINE OUT level control	16
11 CDR drive (disc tray)	16
12 Remote control sensor	16
Controls, Connections (rear)	
1 MIX OUT jacks	17
2 LINE OUT jacks	17
3 AUX IN jacks	17
4 DIGITAL IN and OUT jacks	17
5 REMOTE RC-5 IN and OUT jacks	17
6 REMOTE EXT. INT. switch	17
7 FOOT PEDAL jack	17
8 Power plug	17
9 Power switch	17
How to Play	
How to Play a CD (basics)	18
How to Pause	18
How to Stop	18
How to switch between drives	18
How to display time	18
How to select tracks	19
How to Search	19
How to play a Single Track	19
How to cue to music (cue to audio)	20
How to adjust the cue point	20
How to use Voice Reduction	21
How to enter CHANGER MODE	21
How to program tracks	21
How to erase a programed track	22
How to clear a program	22
(table of contents continues)	

Table of Contents continued

Topic	page
How to program tracks for recording	22
How to Record	
How to record your voice or instrument (basics)	23
SCMS	24
How to copy an existing CD (basics)	24
Select record mode	
REC with CD	25
RECORD	25
COPY + LISTEN	25
COPY 2X	25
COPY 2X+FINAL	25
CONV HALFSPEED	25
SYNC RECORD	25
SYNC RECORD +FINAL	25
Recording tips	25
Record Adjustments	
AUTO TRACK and AUTO STOP defaults ...	26
AUTO TRACK	26
How to turn AUTO TRACK ON or OFF	26
AUTO STOP	27
How to turn AUTO STOP ON or OFF	27
How to adjust the MIC EQUALIZER	27
REC LEVEL	27
How to adjust SPLIT BALANCE	28
How to adjust REC BALANCE	28
How to select filters	29
How to erase	
How to erase the last track	30
How to erase the entire disc	30
How to finalize	30
How to Finalize a CD-R or CD-RW disc	31
How to Unfinalize a CD-RW disc	31
About the Remote	32
Track Skip forward button	33
Track Skip backward button	33
AMS button (Automatic Search)	33
TR INC (Track Increment)	33
About CD discs	34
Which discs to use	34
Disc cleaning	34
CD text	35
CD text during playback	35
Recording CD text	35
How to view CD text	36
How to erase CD text	37
RC-5 remote control codes	37
Troubleshooting	38
Maintenance	38
Specifications	39
Warranty	40

Introduction

The PSD300 CD recording system is a CD player with a built-in CD recorder. It includes features designed for a music teacher, professional musician, vocalist, or studio.

For musical practice you can:

- select A-B (point to point) repeat playback
- adjust KEY and TEMPO (adjust the musical pitch and/or speed of any CD)

For CD recording you can:

- record on CD-R or CD-RW discs
- record any of the playing options (listed below)

For CD playing you can:

- auto cue (start at the beginning of the audio and adjust the auto cue point)
- use voice reduction (reduce the volume of the voice track on a CD)
- add (mix in) your own microphone or instrument input.
- connect to an amplifier/speaker system
- connect to an external CD recorder
- connect an additional CD player (or other line input) to the PSD300 and mix that input

Drive terminology:

In this manual the top loading drive is for playback only and is referred to as the CD drive.

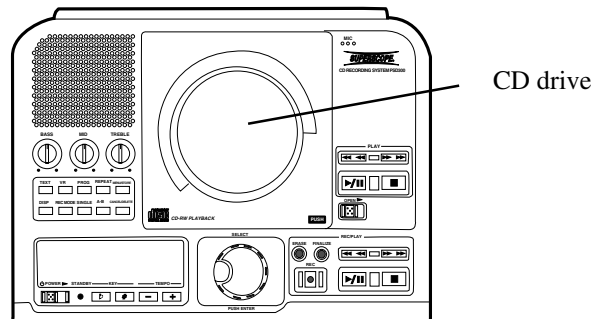

The front, tray loading drive is for recording and playback and is referred to as the CDR drive.

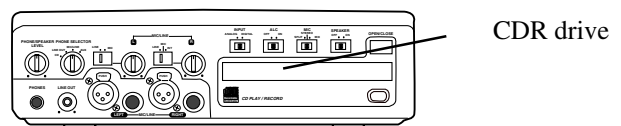

Package contents

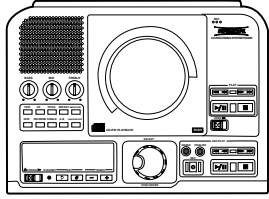

PSD300 unit

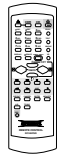

Infrared remote control

Power cord

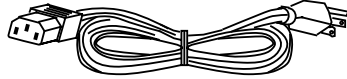

Audio cable



AA batteries (2)

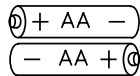

Remote batteries

Press and lift at arrow to open the remote control battery compartment.

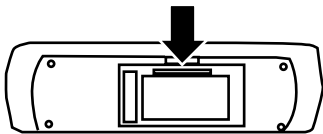

Install two AA batteries.

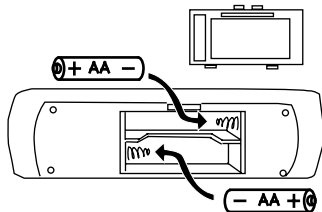

Replace compartment cover.

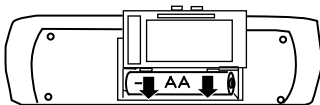

When disposing of used batteries, please comply with governmental and environmental regulations.

Connections (basic)

Install on a table or other flat, stable, surface.

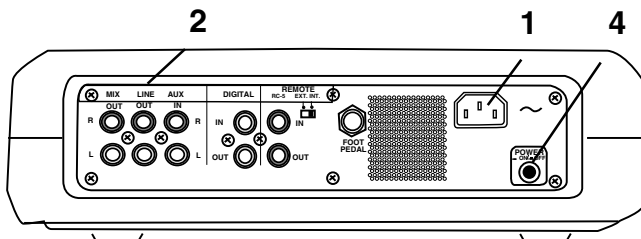

1 Plug in to 110 VAC power

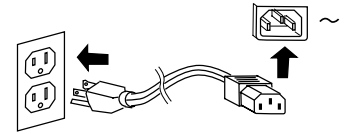

2 Connect your amplifier and speaker system (optional)

Connect the supplied Right and Left RCA audio



cable to LINE OUT and then connect to the input of an amplifier, receiver or other external unit, typically CD input.

3 Speaker: switch the internal speaker OFF and turn your amplifier on. If an external amplifier system is unavailable switch the internal speaker ON.

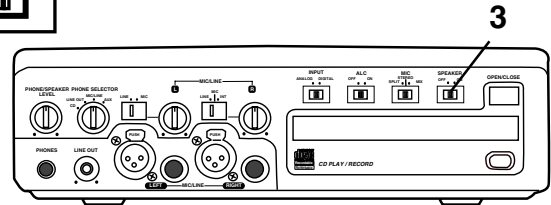
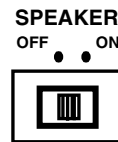

4 POWER Push the POWER OFF/ON button so it is ON (in position).

STANDBY



POWER

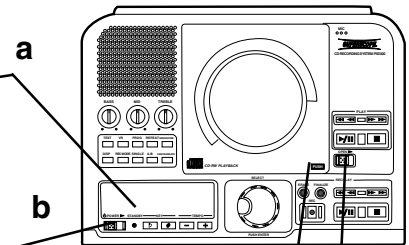

The STANDBY light **a** will be lit. Slide the POWER switch **b** to the right. The STANDBY light will go out.

6

CD READ will flash on the display.

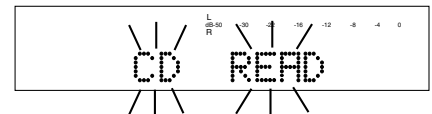

Then the display will read CD NO DISC.

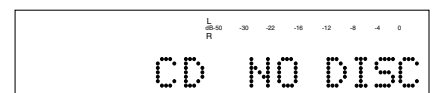

Controls, Display (top)

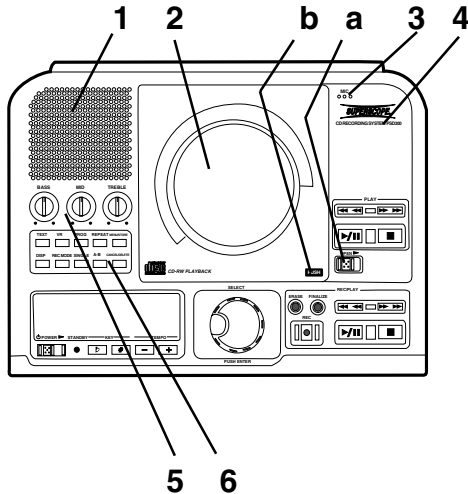

1 Speaker grill

The built in full range speaker allows listening to a CD without having to connect to other equipment for amplification.

2 CD drive

The top loading drive is for playback only. The PSD300 can playback CD, CD-R and CD-RW discs.

A disc being played can be heard over the built in speaker, can be recorded on the CDR drive, or output to an external amplification system or recording device via LINE OUT or DIGITAL out connections.

The CD drive is opened by the OPEN slide switch (a), and closed by pushing on the corner marked PUSH (b).

3 MIC (microphone)



Built in microphone.

4 PSD300 Model number

5 Tone controls

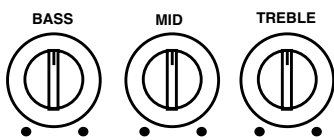

Turning a knob controls the level of the corresponding frequency range of

the CD being played in CD drive. Level adjustments apply to the internal speaker, headphone jack and LINE OUT output. Turn clockwise to boost the frequency and counterclockwise to attenuate it. Level adjustments do not apply to MIX OUT.

TREBLE High frequencies (6 kHz)
MID Middle frequencies (2 kHz)
BASS Low frequencies (150 Hz)

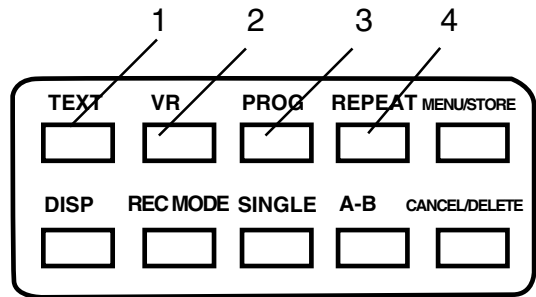

6 Control buttons

1 TEXT button

Activates scrolling text in the display. When a CD with text is first read the text is automatically displayed and scrolls across.

2 VR button (voice reduction)

Push and release to activate voice reduction, a special processor that reduces the volume of the vocal track on a CD.

VR ON is displayed momentarily when voice reduction is switched on.

Push and release the VR button again to turn voice reduction off.

VR OFF is displayed momentarily.

Voice reduction is useful for vocal performers who want to add their own voice through a microphone for playback or recording. The amount of voice reduction varies with the method of mastering used in the original recording.

3 PROG button (program)

Push and release to enter programming mode. Programming lets you select tracks for playback in the CD drive only. Up to 30 tracks can be selected in any order you desire. See **How to program tracks** for a full discussion of this feature.

4 REPEAT button

There are two repeat modes, entire CD and track.

Entire CD: while playing a CD in either drive push and release once to repeat the entire CD.



a REPEAT is lit and steady in the display.

Controls, Display (top) continued

6 Control buttons continued

4 REPEAT button continued

Track: push and release REPEAT twice to repeat only the track being played.

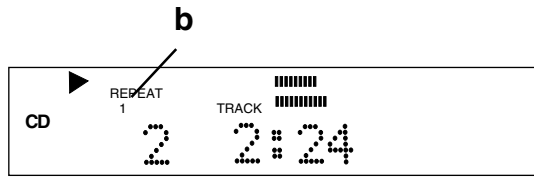

b REPEAT 1 is lit and steady in the display.

Push and release a third time to exit REPEAT.

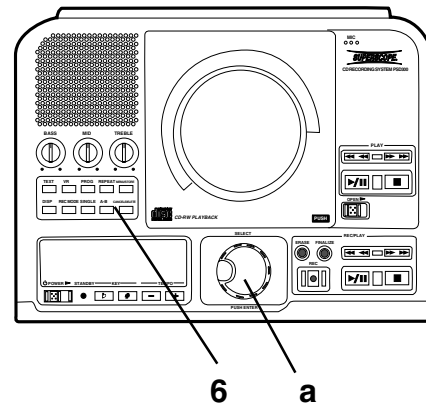

5 MENU/STORE button

Push and release to enter Menu mode.

Menu selections and changes are made using the SELECT control (**a**). Turn the SELECT control to scroll through the options. Push and release the SELECT control to select the option. Push and release the MENU/STORE button to store changes and exit Menu mode.

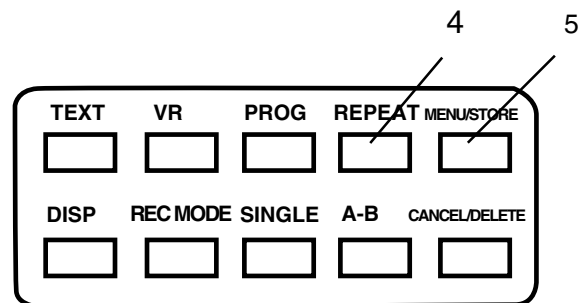

Menu selections are available depending on which drive (CD or CDR) is selected, if the CD is stopped or in Play/Pause, and if REC is selected. The table below shows which menu selection is available under which conditions. The table also lists which page of this manual contains instructions for that menu item.

Menu Item	CD/CDR		CDR REC/REC Pause	Page
	Stop	Play/Pause		
AUTO TRACK			X	27
AUTO STOP			X	28
REC BALANCE			X	29
TEXT EDIT	X			35
TEXT ERASE	X			37
TEXT VIEW	X			36
MIC EQUALIZER	X	X	X	27
SPLIT BALANCE	X	X	X	29
CHANGER MODE	X			22
FILTER SELECT	X	X	X	30

Notes:

1. AUTO TRACK, AUTO STOP, REC BALANCE only operate in REC MODE.
2. TEXT EDIT, TEXT ERASE only apply to unfinalized discs in the CDR drive.
3. CHANGER MODE is only selectable in Stop.

Controls, Display (top) continued

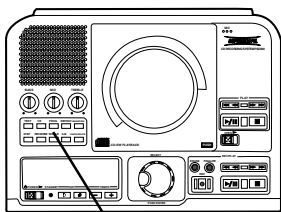

6

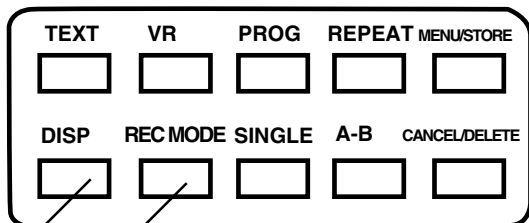

6

7

6 Control buttons continued

6 DISP button (display)

While playing a CD in either drive push and release once to display the remaining play time for the track.

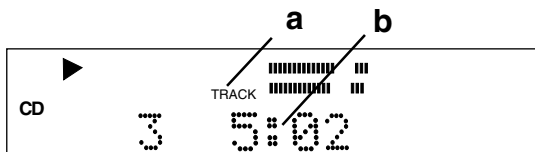

a Only TRACK is lit and steady.

b The countdown time is for the track being played.

Push DISP and release a second time and the remaining play time for the entire CD is displayed.

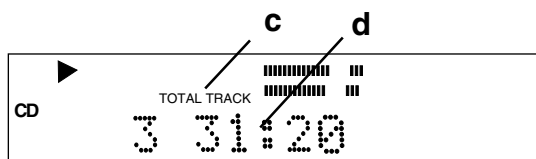

c TOTAL TRACK is lit and steady.

d The countdown time is for the entire CD.

Push DISP and release again to return to the default display showing elapsed track time.

7 REC MODE button

With a CD-R or CD-RW disc in the CDR drive, push and release to enter recording mode. Turn the SELECT control to select the recording mode. Then push and release the SELECT control to choose that mode.

Note: When recording from a CD in the CD drive when tracks are programmed the recording follows the program, if not the entire disc is recorded.

The 8 recording modes are:

REC with CD

This mode allows you to record along with a CD. You can add your voice or instrument via the MIC/LINE jacks, INT microphone, or AUX input. Monitor the recording process using the headphone jack, internal speaker, or LINE OUT.

RECORD

If no CD is present in the CD drive this is the first REC mode that appears in the REC mode menu. You can record using the INT mic, MIC/LINE inputs and/or AUX inputs or DIGITAL input.

COPY + LISTEN

This mode is used to digitally copy a CD in real-time while listening to it. This is an internal recording function that allows no inputs from outside sources.

COPY 2X

Digitally copy individual or programmed tracks or an entire disc. This is an internal recording function that allows no inputs from outside sources.

COPY 2X +FINAL

This is the quickest way to digitally copy individual programmed tracks or an entire disc. This is an internal recording function that allows no inputs from outside sources.

CONV HALFSPEED

This will record individual or programmed tracks at half speed. The converted recording will play one octave lower which provides a powerful new tool for difficult music transcription.

SYNC RECORD

This REC mode is used to automatically engage the recording process from an outside digital or analog source including DAT, minidisk, cassette tape or LP for example.

SYNC RECORD+FINAL

Use this REC mode to automatically start the recording process from an outside digital or analog source including DAT, minidisk, cassette tape or LP for example.

Controls, Display (top) continued

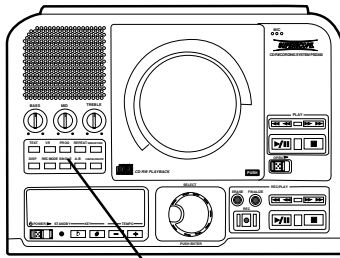

6

6 Control buttons continued

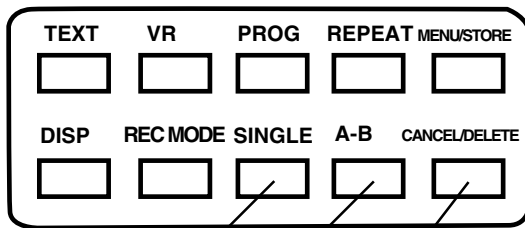

8

9

10

8 SINGLE button

Push and release to toggle Single Track Play on or off.

While in Single Track Play, when a track is selected with the SELECT control, the track does not automatically start playing but is paused and cued up at the beginning of the audio (example display follows), and the Play pause button flashes.

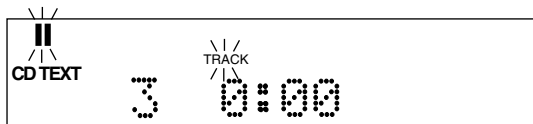

While playing in Single Track Play the Play (a) and TRACK (b) displays are flashing, and the time counter (c) is counting up indicating elapsed time (example display below).

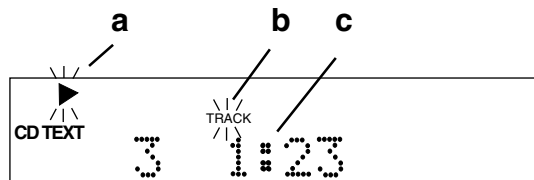

When the track is finished the PSD300 will automatically pause, cued to music, at the beginning of the next track.

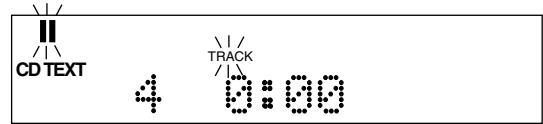

9 A-B button

While a CD is playing push and release to start point A to point B repeat play.

Point A (starting point) is set when the A-B button is pushed and released. The next push and release of the A-B button sets point B (ending point). Play repeats between A and B. Example display:

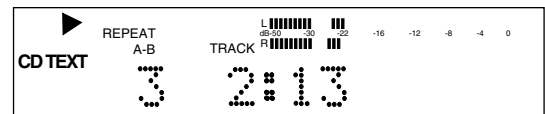

During A-B repeat push and release the A-B button. Point B becomes the new A point and the next push and release of the A-B button sets a new B point.

OR

During A-B repeat push and hold the A-B button for one second to keep the A point. Push and release the A-B button to set a new B point.

To exit A-B repeat press the REPEAT button, play continues, or the Stop button, play ends.

10 CANCEL/DELETE button

Push and release to delete tracks from a program, to delete text when entering CD text, or return to a higher level in the Menu.

Controls, Display (top) continued

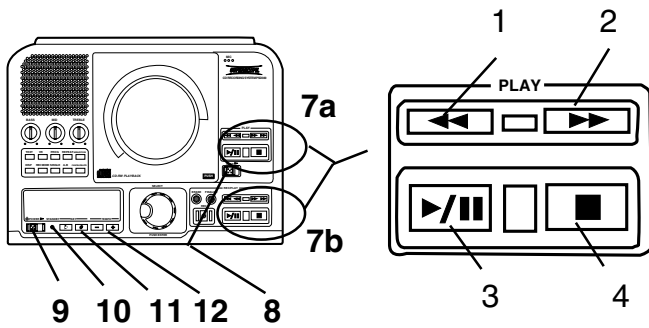

7 Play controls

Play controls **7a** control playback of a disc in the CD drive. Another set of play controls **7b** control playback of a disc in the CDR drive.



1 Fast backward search button

Push and hold during playback to search backward. While searching samples of audio are played to help you find the point you are searching for. Returns to playing forward when the button is released.



2 Fast forward search button

Push and hold during playback to search forward. While searching samples of audio are played to help you find the point you are searching for. Returns to playing forward when the button is released.



3 Play/Pause button

Push and release to start play of a stopped or paused disc. Push and release during play to pause. Button lit during play, flashing during pause.

Example display during pause.

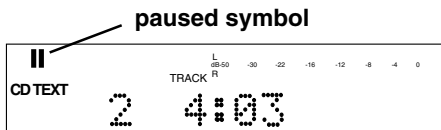

4 Stop button

Push and release to stop play of a playing or paused disc. When a disc is not playing or paused, push and release to clear a program. Button lit when drive is selected and stopped.

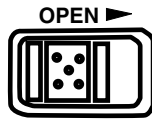

8 OPEN switch

Slide the OPEN switch to the right to open the CD drive. A CD playing automatically stops. CD OPEN is displayed.



9 Standby POWER switch

Slide the Standby POWER switch to the right to turn power on or off. POWER button on rear of unit must be ON (the red STANDBY

light must be lit).

STANDBY



10 STANDBY light

STANDBY light (red) is lit when power is switched off by the Standby POWER switch on the unit or remote.

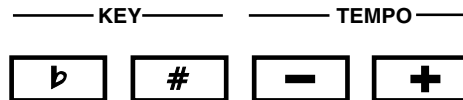

11, 12 Control of KEY and TEMPO

The PSD300 allows control of key (musical pitch) and tempo (CD playback speed). The CD drive must be selected to allow control of KEY and TEMPO.

KEY



11 KEY controls

Press **b** to lower or **#** to raise the key (musical pitch). KEY control can change the CD sound by up to plus or minus one octave.

The **KEY** control system works on the following musical principles:

- 100 cents = 1 half step
- 2 half steps = 1 whole step
- 12 half steps = 1 octave

Press **b** or **#** once to start KEY control. Then press once to change the key by a 12.5 cents increment. The display shows the increment rounded to 0.13 cents. Press and hold to quickly decrease or increase the key. Press both buttons at the same time to return to 0.00 position.

Controls, Display (top) continued

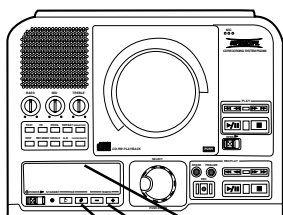

11 12 13

11 KEY controls continued

Notes

- If the **b** or the **#** buttons are pressed while another display (such as CD-TEXT) is shown, the current position of the KEY control is shown first. Once one of the **b** or **#** buttons are pressed a second time the KEY changes.
- Once the key has been adjusted by pressing either the **b** or **#** button, it is possible to also adjust the tempo (CD playback speed). For a key adjustment in a range of ± 5.00 half steps, the tempo can also be adjusted -33% to +50%.
- Pressing the STOP button during stop mode will reset the KEY to 0.00 position



12 Tempo controls



TEMPO can be changed in increments of 1% up to +50% and -33%.

A "+" button increases the speed in steps of 1%.
 A "-" button decreases the speed in steps of 1%.
 Holding down either a "+" or a "-" button for more than 1 second causes the tempo adjustment to change rapidly. Pressing both the "+" and "-" buttons at the same time returns the **TEMPO** to 0% (normal speed).

TUNING Once the Tempo has been adjusted by pressing either the - or + button, it is possible to also fine tune (TUNING) the key (musical pitch).

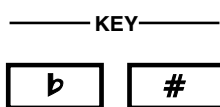

Press **b** to lower or **#** to raise the key (musical pitch).
TUNING lets you tune the CD output to a musical instrument (CD drive only).

Useful when practicing an instrument because it lets you adjust the music practice source to your instrument.

The **#** button raises the tuning in 0.1% increments and is displayed as a whole number with a + sign. For example, to raise the tuning of the CD by 1.5% the display should show "+15".

The **b** button lowers the tuning in 0.1% increments and is displayed as a whole number with a - sign. For example, to lower the tuning by 0.8% the display should read "-8".

13 Display

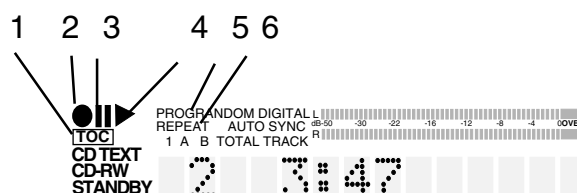

TOC 1 TOC

Lit when TOC (disc table of contents) information is held in memory. The table of contents includes the total number of tracks, playback time and other CD text if provided. Flashes during recording.

2 Record indicator

Lit when recording.



3 Pause indicator

Lit when recording or playback has been paused.



4 Play indicator

Lit during recording or playback.

PROG **5 PROG indicator**

Lit during programming mode (selecting track playback sequence).

REPEAT **6 REPEAT indicator**

Lit during a repeat operation.

REPEAT **1** When the 1 indicator is also lit only the currently playing track is repeated.

Controls, Display (top) continued

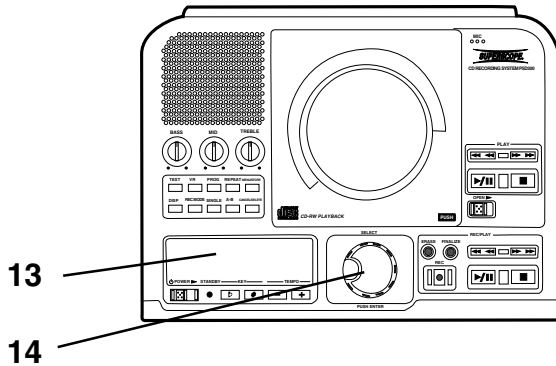

13 Display continued

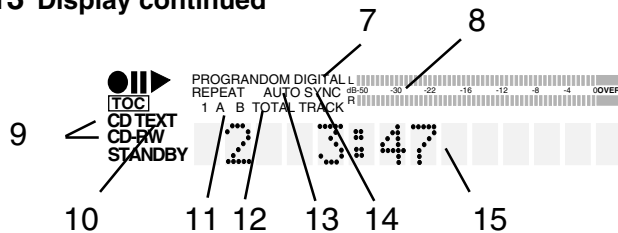

DIGITAL 7 DIGITAL indicator

Lit during digital playback or recording.
Not lit during analog playback or recording.



8 Level meter

Displays the level of the Left and Right channels of audio from the music source. During CD playback this is the audio level of either the CD drive or the CDR drive. During recording this is the audio level of all music sources feeding the CDR drive.

CD 9 CD indicator

CD-RW Displays CD, CD-R, or CD-RW telling you the type of disc that is in the selected drive.

TEXT 10 TEXT indicator

TEXT is displayed when the CD being played includes CD TEXT information. Or when TEXT mode is selected to enter CD TEXT information onto a CD you are recording.

A-B 11 A-B indicator

A- is lit after pushing the A-B button once indicating that the beginning of audio segment to be repeated has been selected. REPEAT is also lit. A-B is lit after pushing the A-B button a second time. The audio segment from A to B is repeated indefinitely.

TOTAL TRACK 12 TOTAL TRACK indicator

TOTAL TRACK is lit when the display information (time to end) applies to the whole CD rather than the track being played.

TRACK is lit when the display information (time to end) applies to the track being played rather than the whole CD.

AUTO 13 AUTO indicator

Lit when tracks are automatically being determined (by digital subcode or audio sensing).

SYNC 14 SYNC indicator

Lit when the SYNC RECORD mode is on.

15 Alphanumeric display

Information, instructions and error messages can be displayed. The example shown indicates track 2 is being played and it is three minutes and forty seven seconds to the end of track 2.



SELECT

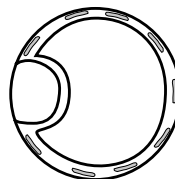

PUSH / ENTER

14 SELECT control

This is the "master" control for the PSD300. Push and release to switch control between the CD drive and the CDR drive.

For most operations you turn to select, then push and release to confirm and enter your selection.

- In PROG mode turn to select track, then push and release to program the track.
- In Play mode turn to select the track.
- When recording, selects recording level.
- In MENU mode turn to scroll through menu selections.

Controls, Display (top) continued

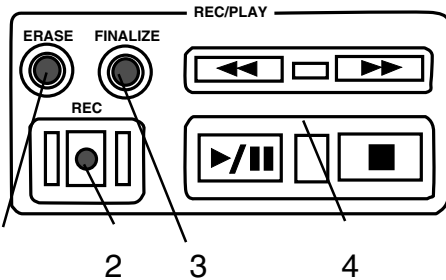
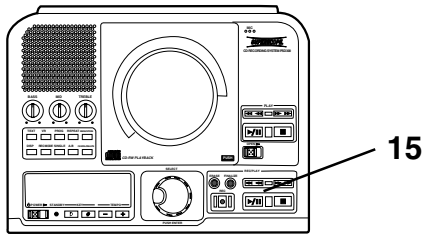

15 REC/PLAY controls



1 ERASE button light
Push and release to enter ERASE mode. See **How to erase**.



2 FINALIZE button light
Push and release to enter FINALIZE mode. See **How to finalize**.

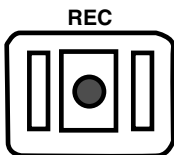

3 REC (record) button light
When flashing and prompted by the display to PUSH REC KEY, push and release to start recording. See **How to Record** for recording modes. Also used when finalizing.

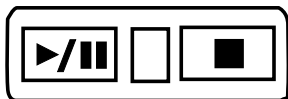

4 PLAY controls
CDR drive controls work the same as the play controls for the CD drive. See **PLAY controls**.

Controls, Connections (front)

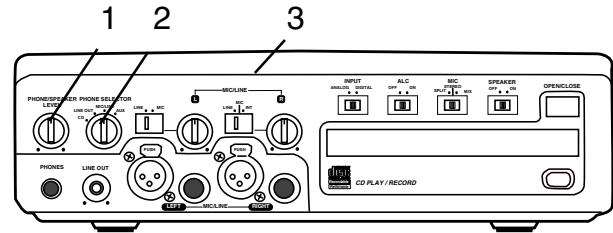

PHONE/SPEAKER LEVEL

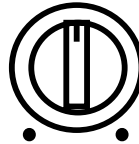

switch to OFF.)

1 PHONE/SPEAKER LEVEL control

Turn to adjust the level (volume) of the built-in speaker and headphones plugged into the PHONE jack. (To listen to headphones only turn the SPEAKER OFF/ON

PHONE SELECTOR

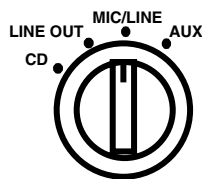

2 PHONE SELECTOR

Turn to select the audio input to the PHONE jack and internal Speaker.

CD – CD drive.

LINE OUT – Audio available at the LINE OUT output jacks.

MIC/LINE – Audio being input via the MIC/LINE/INT input jacks.

AUX – Audio being input to the AUX IN jack.

3 MIC/LINE/INT controls and input jacks

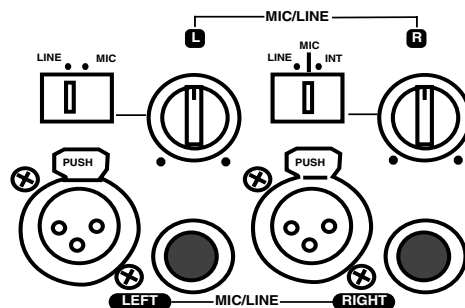

Left and right microphones or instruments via phone jacks or via XLR connectors are input here. LINE/MIC switches on each input channel permit, for example, input of an instrument on the left channel (LINE) and a mic level input on the right channel (MIC).

Controls, Connections (front) continued

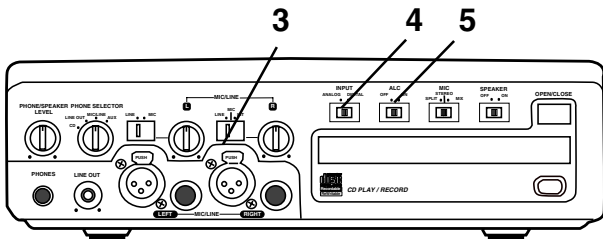

3 MIC/LINE/INT controls and input jacks continued

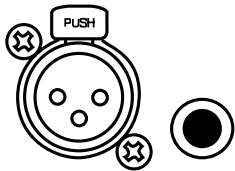
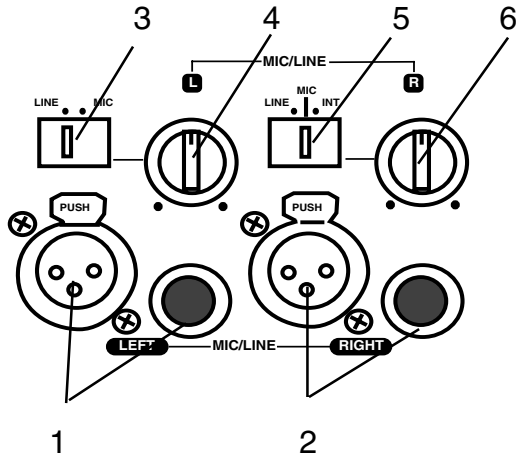

1 Left XLR or 1/4" input jack
 Plug in an instrument or other line level audio device here to provide audio to the left stereo channel.

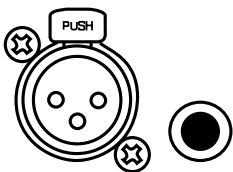

2 Right XLR or 1/4" input jack
 Plug in an instrument or other line level audio device here to provide audio to the right stereo channel.

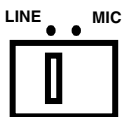

3 Left LINE MIC switch
 Switch to LINE for a line level input or to MIC for a microphone level input.

Note: To mix two microphones from the front inputs with a stereo line input, use the AUX input on the rear for the stereo line input.

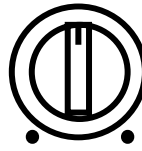

4 Left level control
 Turn to adjust the level of the left input.

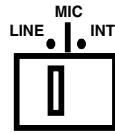

5 Right LINE MIC INT switch
 Switch to LINE for a line level input or to MIC for a microphone level input. Switch to INT for the internal microphone.

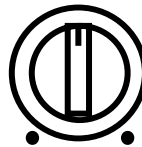

6 Right level control
 Turn to adjust the level of the right input.

Note: When internal mic is selected both the Left level control and the Right level control are active. To record the internal microphone to both the left and right channels adjust both Left and Right level controls.

Note: To avoid feedback, turn the internal SPEAKER OFF/ON switch OFF or reduce the PHONE/SPEAKER LEVEL control, and reduce the LINE OUT level control if connected to an external amplifier.

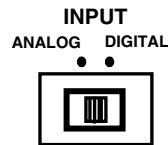

4 INPUT ANALOG/DIGITAL switch
 Select between analog or digital external input. Connect digital output of the source machine to the DIGITAL IN jack on the rear of PSD300.

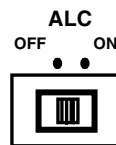

5 ALC OFF/ON switch
 Record level limiter for analog input during recording.

ON – Limits any input signal greater than -12 dB. Left and right MIC/LINE (or INT MIC) level controls should be set to maximum.

OFF – Set level using left and right MIC/LINE (or INT MIC) level controls. Levels in excess of 0 dB may be recorded and may result in distorted recordings.

Controls, Connections (front) continued

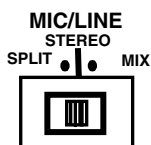
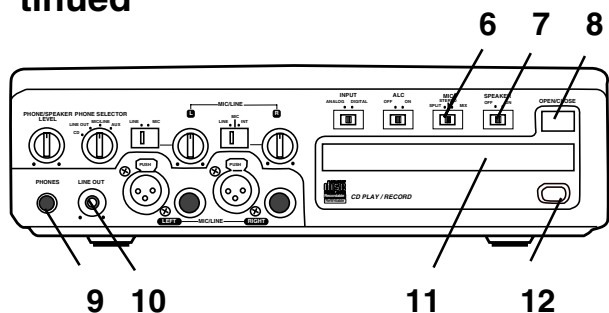

6 MIC/LINE SPLIT/STEREO/MIX switch

Determines how the signal from the CD drive and the signals from the MIC/LINE (or INT MIC) inputs are recorded.

SPLIT – Left and right signals from the CD drive are sent to the left channel of the recording. Left and right signals from MIC/LINE (or INT MIC) are sent to the right channel of the recording. Left and right signals from the AUX inputs are sent to the left and right channels of the recording.

STEREO – Left and right signals from the CD drive are sent to the left and right channels of the recording. Left and right signals from the MIC/LINE (or INT MIC) and/or AUX inputs are sent to the left and right channels of the recording.

MIX – Left and right signals from the CD drive and the AUX inputs are sent to the left and right channels of the recording. MIC/LINE (or INT MIC) inputs are sent to both channels of the recording.

Note: When internal mic is selected both the Left level control and the Right level control are active. To record the internal microphone to both left and right channels adjust both Left and Right level controls.

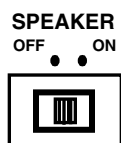

7 SPEAKER OFF/ON switch

Turns the built-in speaker OFF or ON.

OPEN/CLOSE



8 OPEN/CLOSE switch

Push and release to OPEN the CDR drive.

CDR drive open

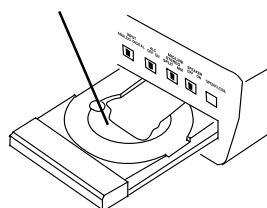

To CLOSE the CDR drive, push and release the OPEN/CLOSE switch.

PHONES



9 PHONES jack

Plug stereo headphones in here. Adjust headphone volume with the PHONES/SPEAKER LEVEL control.

LINE OUT



10 LINE OUT level control

Turn to adjust the level of the output to the LINE OUT jacks.

11 CDR drive (disc tray)

In this manual this drive is referred to as the CDR drive. The CDR drive is used for recording and can record CD-R and CD-RW discs. The CDR drive can also playback CD, CD-R and CD-RW disks



12 Remote control sensor

Sensor for the supplied wireless remote control.

Note: Set the REMOTE EXT. INT. switch on the back to INT. to enable the wireless remote control.

Controls, Connections (rear)

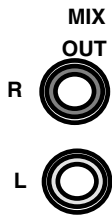
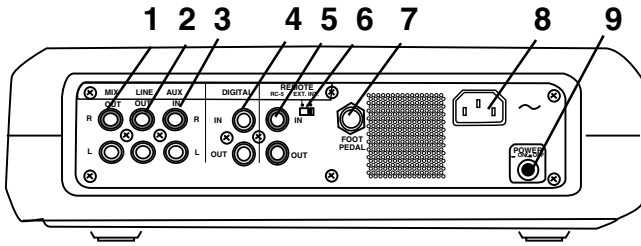

1 MIX OUT jacks

Plug Right and Left RCA audio cables in here to connect to the input of an amplifier or other external unit. Use for recording onto an external recorder.

Output from the CD drive and MIC/ LINE (or INT MIC) and/or AUX

jacks are output as line level output to an external recorder or amplifier. The signal is output before going to the CDR drive, so it is available for monitoring or recording even if the CDR drive is stopped. This signal cannot be equalized by the PSD300 tone controls.

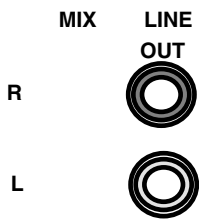

2 LINE OUT jacks

Plug Right and Left RCA audio cables in here to connect to the input of an amplifier or other external unit. When the CDR drive is not recording the LINE OUT jacks output the MIX

out signal. This signal can be equalized by the PDS300 tone controls.



3 AUX IN jacks

Plug Right and Left RCA audio cables in here to connect to the output of an external unit.

Use for recording onto the CDR drive from an external audio source such as a cassette deck.



4 DIGITAL IN and OUT jacks

Plug RCA coaxial cables in here to connect to the input and/or output of an external digital unit.

Use IN for recording onto the CDR drive from an external digital audio source.

Use OUT for going to an external digital device.

REMOTE RC-5



5 REMOTE RC-5 IN and OUT jacks

Plug RCA audio cables in here to connect to the input and output of an RC-5 remote control system. The RC-5 control code list is on page 38.

Notes:

- For more information on the RC-5 system and details regarding its operation please contact Superscope Technologies.
- When an RC-5 remote control system is not used the REMOTE EXT. INT. switch should be at INT.

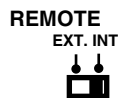

6 REMOTE EXT. INT. switch

Switch to EXT. (external) when an external RC-5 remote control system is used.

Notes:

- Switch to INT. (internal) to enable the supplied IR (infrared) remote.
- A list of the RC-5 remote control codes is on the page 38.



7 FOOT PEDAL jack

An optional foot pedal can provide Play/Pause control for the CD drive and the CDR drive.

Foot pedal (FT200) is available from Superscope Technologies Inc.

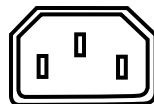

8 Power plug

Plug one end of the supplied power cord in here and the other into a 110 VAC outlet.

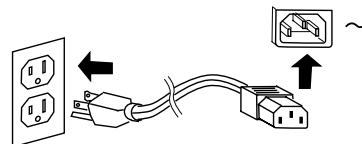

9 Power switch

Push and release to turn power ON (in position). Push and release to turn power OFF (out position).

Normally, to retain memory, leave this switch at ON and turn power on and off with the Standby POWER slide switch on the top of the unit.

How to Play

How to Play a CD (basics)

1 Connect and turn on the PSD300, see Connections (basic) on page 6.

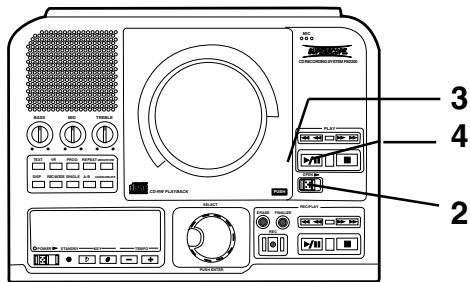

2 Slide the OPEN switch to open the CD drive.

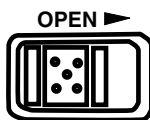

3 Insert your CD and push at PUSH to close the CD drive.

CD READ will flash on the display.

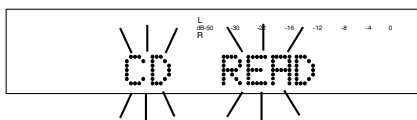

If CD text is available the CD title/artist will scroll across the display.

Then the display will show disc information (example shown).

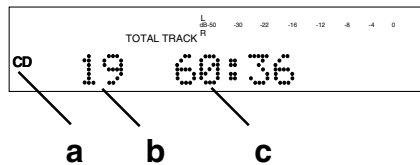

- a The type of disc (CD, CD-R or CD-RW) is shown.
- b The number of tracks on the disc.
- c The total playing time of the disc.

4 **Play** Push the Play/Pause button to begin play. The CD will play to the end and stop.

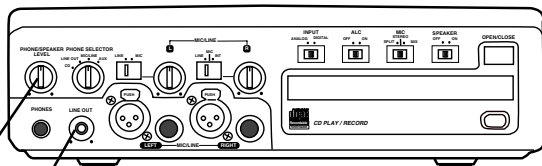

Adjust internal speaker or headphone volume with the PHONE/SPEAKER level control **d**.

Adjust the LINE OUT level with the control **e** and your amplifier's volume controls if using an external amplifier.

How to play

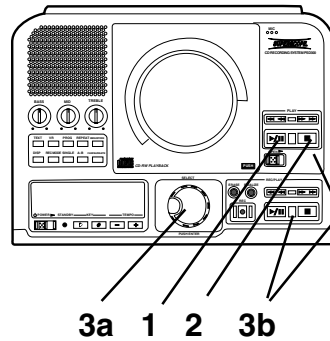

How to Pause



Push and release the Play/Pause button (1) to Pause. When paused, push and release to continue play from the same point.

How to Stop



Push and release the Stop button (2) to Stop. When Play/Pause is pushed, play starts from the beginning of the disc.

How to switch between drives

SELECT

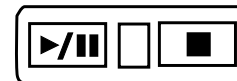

3b

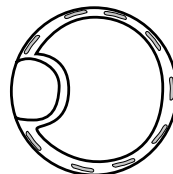

3a

PUSH / ENTER

If both the CD drive and the CDR drive have CDs inserted and ready for play you can switch between the drives during play, stop or pause by pushing and

releasing the SELECT control (3a) or the Play/Pause or Stop buttons (3b).

How to display time

There are three modes of time display:

- A Elapsed track time
- B Total remaining disc time
- C Remaining track time

A Elapsed track time

The default time display shows the elapsed time on the track being played.

Example display.

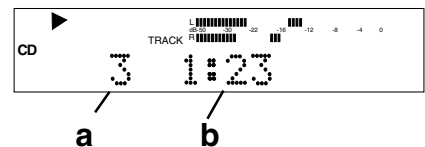

That track 3 (a) has been playing for 1 minute and 23 seconds (b).

How to play continued

B Total remaining disc time

Push and release DISP (4) once. The display shows the total time remaining on the disc counting down.

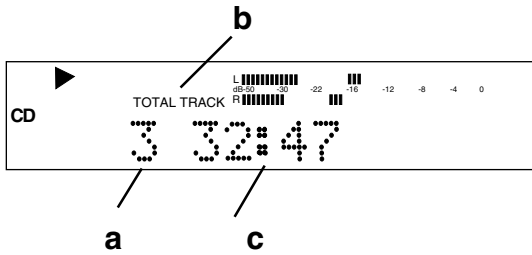

The example display indicates that track 3 (a) is playing, and total track (total disc) (b) has 32 minutes and 47 seconds to play (c).

C Remaining track time

Push and release DISP (4) another time. The display shows the time remaining on the track counting down.

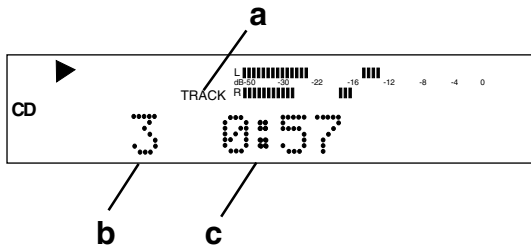

The example display indicates that track time is displayed (a) track 3 is playing (b) and has 0 minutes and 57 seconds of remaining play time (c).

Push and release DISP (4) a third time. The display returns to the track time counting up.

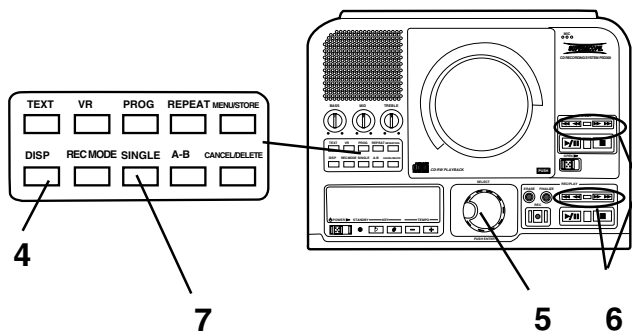

How to select tracks

You can select tracks during Stop, Play or Pause.

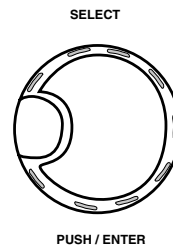

Turn the SELECT control (5) to choose the track. During play wait about a second or push and release the SELECT control to switch to the beginning of that track. During Stop or Pause push Play/Pause to begin playing the selected track.

How to Search



While playing (CD or CDR drive) push and hold a Fast backward search or Fast forward search button (6).

Samples of audio are played while searching backward or forward. After a couple of seconds of holding the search speeds up.

For more accurate positioning on the CD drive push and release the Fast backward or Fast forward search button during Pause. Each push and release is approximately one half second of audio.

How to play a Single Track

While stopped push and release the SINGLE button (7).

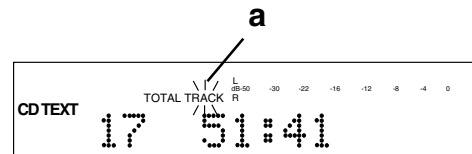

Example display shows TRACK flashing (a).

Turn the SELECT control to choose the track you wish to play.

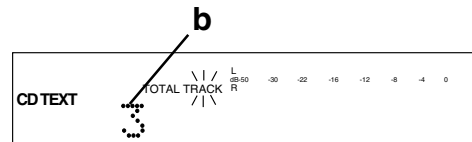

Example display shows TRACK 3 selected (b).

Push and release Play/Pause.

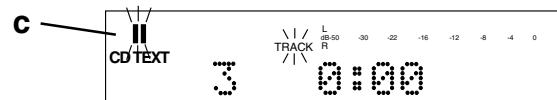

The selected track will be cued to music and paused. Paused symbol flashing (c).

How to play continued

Push and release Play/Pause.

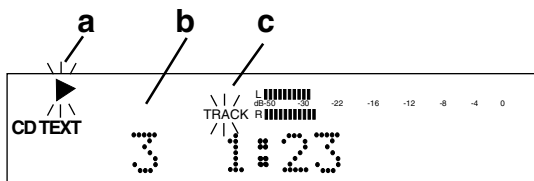

Example display:

- a Play symbol flashing indicates track is playing.
- b Example track #3 is playing
- c Flashing "TRACK" indicates single track play.

When the track is completed the PSD300 remains in Single track, paused at the beginning of the next track and cued to music.

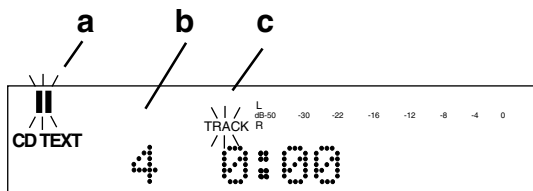

Example display:

- a Paused symbol flashing indicates track is paused.
- b Example track #4 is cued.
- c Flashing "TRACK" indicates single track play.

Push SINGLE to exit Single Track.

How to cue to music (cue to audio)

Normally there is some silence from beginning of a track (track ID position) to the beginning of the music (audio). Cue to music skips the silence so you can directly switch to audio from Play/Pause mode.

In Single Track the PSD300 automatically turns cue to music on. Push SINGLE to enter cue to music.

How to adjust the cue point

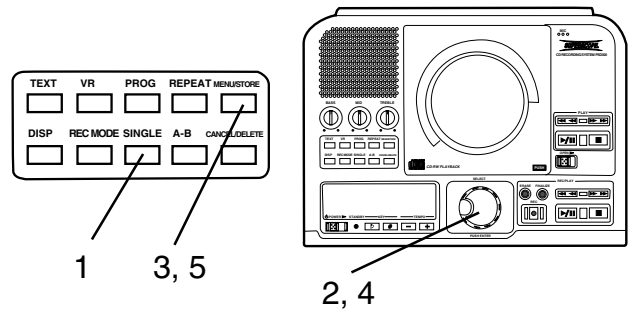

The cue point (start point of audio) is detected by the PSD300 as volume exceeding a threshold of audio.

To adjust

- 1 With your CD in the CD drive, at Pause, and with SINGLE track selected.
- 2 Turn the SELECT control to choose the track and push and release the SELECT control to confirm.

Example display.



- 3 Push and release MENU/STORE. The display switches to CUE POINT ADJ.



- 4 Push and release the SELECT control. The display shows O FRAME.



Depending on the specific track, the FRAME adjustment can be from 75 to -75 (75 frames = 1 second).

Turn the SELECT control to change the audio start position. Then push and release the SELECT control to store the adjustment.

- 5 Push and release MENU/STORE to exit.

How to play continued

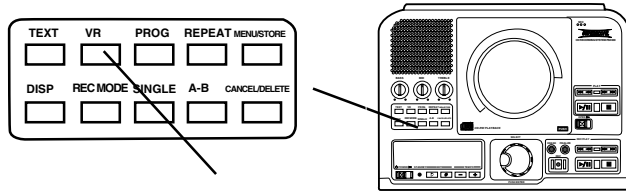

How to use Voice Reduction

Voice reduction is an electronic filter that reduces the relative volume of the audio that during the production process of the commercial CD was mixed in the center channel (between right and left channels). Normally the lead vocal of a CD is mixed to the center channel.

While playing or paused (CD drive only) push and release VR. A single push and release displays the status of Voice Reduction.

Example display.



A second push and release of VR switches the status of voice reduction. When voice reduction is ON VR is displayed during play.

Example display.

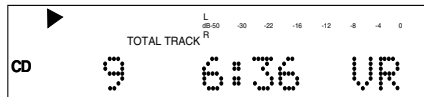

How to enter CHANGER MODE

CHANGER MODE is a continuously playing mode that automatically switches between drives. In CHANGER MODE when the CD drive finishes playing the CDR drive automatically starts playing, and when the CDR drive finishes playing the CD drive automatically starts playing. The tracks on the CD drive can be programmed for CHANGER MODE.

You have to manually push Pause or Stop to stop play.

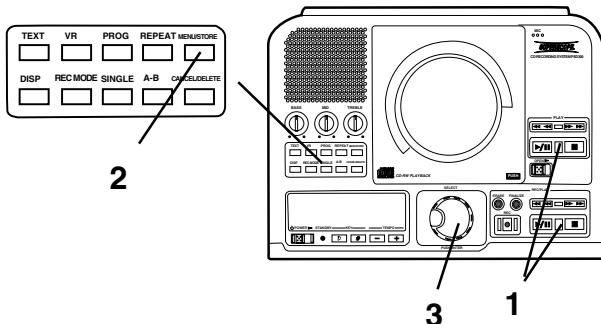

- 1 With the PSD300 in stop mode (stop lit on either the CD or the CDR drive).
- 2 Push and release MENU/STORE.
- 3 Turn the SELECT control so CHANGER MODE is displayed.

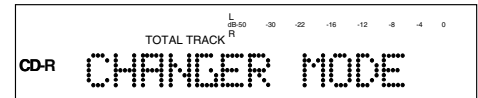

Push and release the SELECT control. CHANGER ON or OFF is displayed.

Example display.

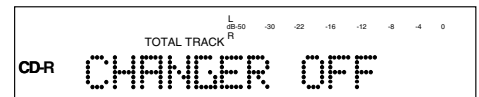

Turn the SELECT control to switch between ON and OFF. Push and release the SELECT control to make selection.

How to Program Tracks

Programming lets you select tracks for playback (CD drive only). Up to 30 tracks can be selected in any order you desire.

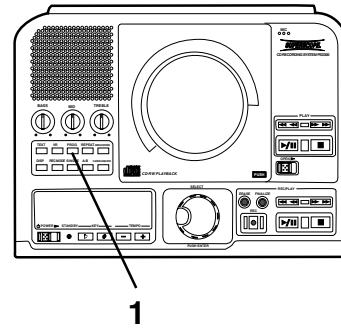

- 1 With a CD in the CD drive and with playback stopped, push and release the PROG button to enter programming. This display appears:

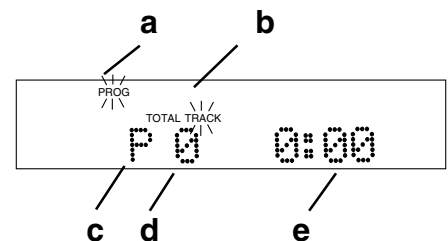

- a PROG is lit and flashing.
- b TOTAL TRACK is lit with TRACK flashing.
- c P indicates "Programmed tracks".
- d The number of tracks programmed is displayed.
- e The total playing time programmed is displayed.

How to play continued

How to Program Tracks continued

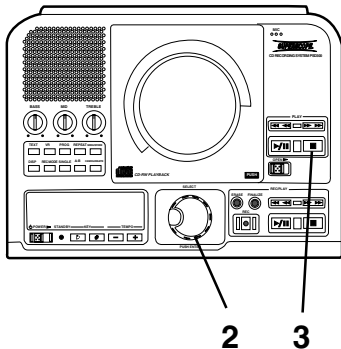

- Turn the SELECT control to display the track desired.

Example display shows track 3 selected.

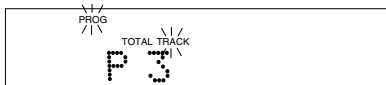

Push and release the SELECT control to enter the selected track, or wait 1.5 seconds and the track is automatically entered.

The display changes to:

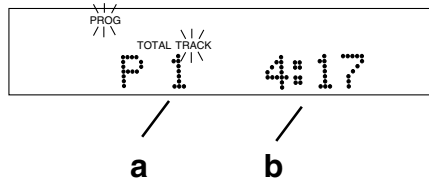

- 1 track is programmed. (In the example track 3 is the first track to be programmed.)
- The total playing time programmed in the example is 4 minutes and 17 seconds.

Repeat step 2 to program tracks in the order you desire. Up to 30 tracks can be programmed. When you try to program a 31st track, this display appears:



If the total time programmed exceeds 99 minutes and 59 seconds the display changes to:

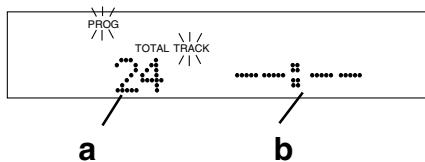

- Number of tracks programmed (example).
- Total time given as dashes.

- Push Play/Pause (a) to play the program.

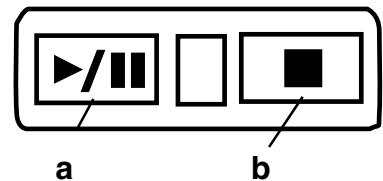

Example display shown.

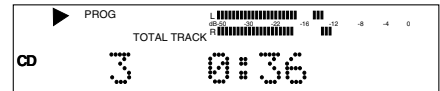

Pause, Stop: While playing the program:

- Push Play/Pause to pause, push again to resume play from that point in the program.
- Push Stop to stop. Push Play/Pause to resume play from the beginning of the program.

How to erase a programmed track

- In Stop mode push and release PROG to enter Program mode.
- Turn the SELECT control to select the track to be erased.
- Push and release CANCEL/DELETE to erase the track.

How to clear a program

Push Stop **b** twice to clear the program and exit program mode.

How to program tracks for recording

- Follow steps 1 and 2 of How to program tracks (above). You can check your program by playing and/or pausing it. With your program at stop:
- Insert a blank recordable CD or CD with space for recording in the CDR drive.
- Select the CDR drive by pressing the Stop button on the CDR drive.
- Push and release REC MODE. REC with CD, COPY+ LISTEN, COPY 2X, or COPY 2X+FINAL are suggested recording modes.
- You will most likely want AUTO TRACK and AUTO STOP ON so your programmed tracks are automatically included. Push and release MENU/STORE to check or change those menu settings. See AUTO TRACK and AUTO STOP for full instructions.

How to Record

How to record your voice or instrument (basics)

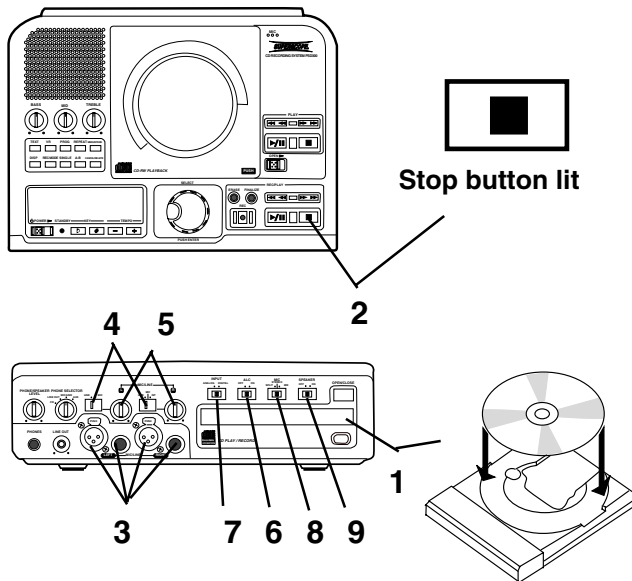

- 1 Insert a blank disc, or a recordable disc with space for additional recording in the CDR drive.
- 2 With the CDR drive at Stop.
- 3 Connect your microphone(s) or instrument(s) to the MIC/LINE jacks on the front of the PSD300.
- 4 Set the LINE MIC switches for microphone input (MIC) or for instrument input (LINE).
- 5 Turn the L and R level controls all the way up (clockwise).
- 6 We suggest switching ALC (record level limiter) ON.
- 7 Set the INPUT switch to analog.
- 8 Set the MIC/LINE switch to STEREO so the left input is recorded on the left channel and the right input on the right channel.

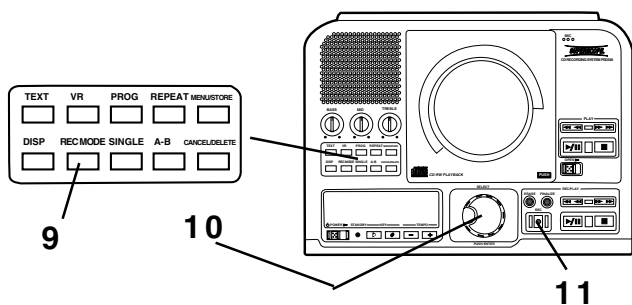

- 9 Push and release REC MODE.

- 10 Turn the SELECT control so RECORD is displayed.

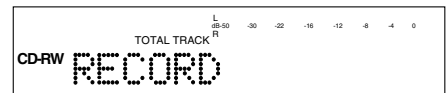

Then push and release the SELECT control to accept the RECORD recording mode.

The display changes to:



The REC button (11) is lit and flashing.

- 11 Push and release REC to begin recording.

Example display while recording.

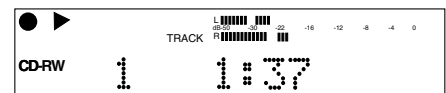

Push and release Stop or Play/Pause to stop recording and to set the end of your recording track and the beginning of the next track.

To play your new recording on other CD players your disc must first be finalized. See **How to finalize**.

How to Record

SCMS (Serial Copy Management System)

The SCMS copy management system is designed to prevent consumer recorders from making unlimited digital copies of a digital source. Most consumer CD recorders will not make a digital copy when SCMS is present in the digital source, while a professional CD recorder (PSD300) will act differently.

If the digital source being recorded on the PSD300 contains no SCMS information then the copy will also not include SCMS. If the digital source material being recorded on the PSD300 contains SCMS information then the copy will also include SCMS.

The SCMS copy management system does not apply to analog source material.

How to copy an existing CD (basics)

OBSERVE REGULATIONS REGARDING COPYRIGHT INFRINGEMENT.

1 Insert a CD in the CD drive.

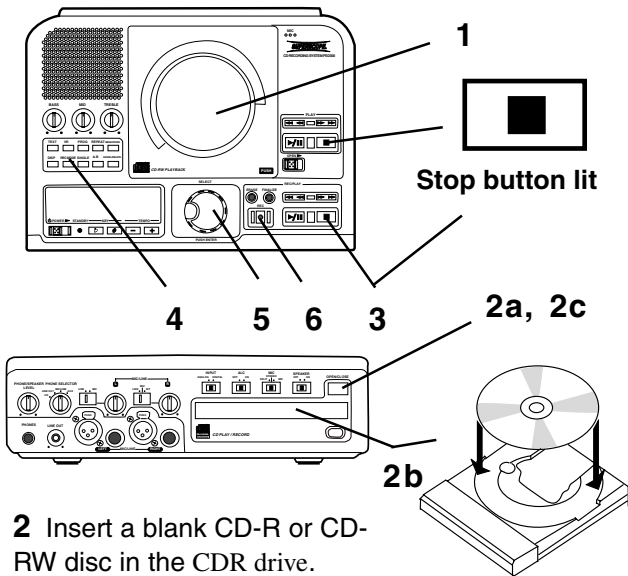

2 Insert a blank CD-R or CD-RW disc in the CDR drive.

- a** Push OPEN/CLOSE to open the disc tray.
- b** Add the blank disc.
- c** Push OPEN/CLOSE to close.

3 Push and release the CDR drive Stop button to activate the drive. After reading the disc BLANK DISC is displayed.

Example display.

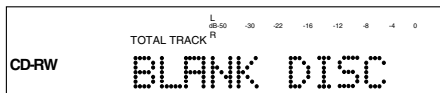

4 Push and release REC MODE. Turn the SELECT control so COPY + LISTEN is displayed.

Example display.

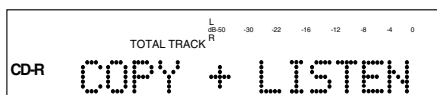

Push and release the SELECT control to accept the COPY + LISTEN recording mode choice.

Example display.

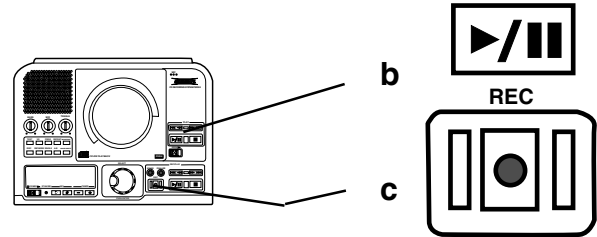

- a** The red rec indicator and the pause indicator in the display are lit.
- b** The Play/Pause button for the CD drive is lit and flashing.
- c** The red REC button is lit and flashing.

5 Push and release the REC button

The CD will play at normal speed and you can listen while recording on the built-in speaker or on an amplifier/speaker system connected to the LINE OUT jacks.

Example display during recording.

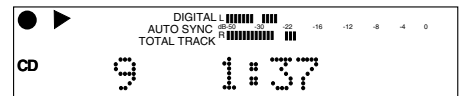

The entire CD will be recorded and recording will automatically stop when completed. This REC mode does not automatically finalize the recorded disc.

6 To finalize push and release the FINALIZE button.

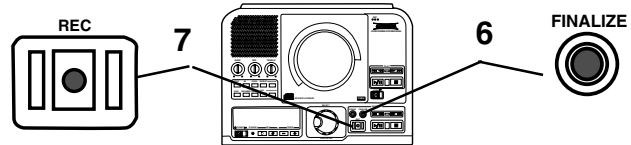

FINALIZE is displayed for a couple of seconds.

Then PUSH REC KEY is displayed.

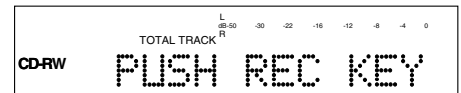
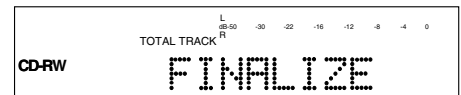

7 Push and release the REC button.

Finalizing counts down for about 2 minutes and automatically stops.

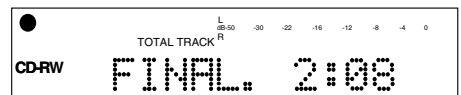

How to Record continued

Select record mode

The record mode (REC mode) sets the PSD300 to expect and accept certain inputs, outputs, and other conditions such as the settings of AUTO TRACK and AUTO STOP, and the easy availability of some adjustments such as REC LEVEL.

The following descriptions will help you select the REC mode that suits your needs.

REC with CD

This mode allows you to record along with a CD. You can add your voice or instrument via the MIC/LINE jacks, INT microphone, or AUX input. Monitor the recording process using the headphone jack, internal speaker, or LINE OUT.

CD recordings must be finalized in order to play back on other CD drives.

RECORD

If no CD is present in the CD drive this is the first REC mode that appears in the REC mode menu. You can record using the INT mic, MIC/LINE inputs and/or AUX inputs or DIGITAL input.

This mode can be used to record live meetings, conferences, concerts, seminars, and also for mastering in the project studio.

CD recordings must first be finalized in order to play back on other CD drives.

COPY + LISTEN

This mode is used to digitally copy a CD in real-time while listening to it. This is an internal recording function that allows no inputs from outside sources.

A 74-minute CD will take 74 minutes to copy and then must be finalized in order to play in other CD drives.

COPY 2X

Digitally copy individual or programmed tracks or an entire disc. This is an internal recording function that allows no inputs from outside sources.

A 74-minute CD will take approximately 37 minutes to copy and then must be finalized in order to play in other CD drives.

COPY 2X +FINAL

This is the quickest way to digitally copy individual programmed tracks or an entire disc. This is an internal recording function that allows no inputs from outside sources.

A 74-minute CD will take approximately 37 minutes to copy and will automatically be finalized at the end of the recording session. The finalization takes approximately 2 minutes.

CONV HALFSPEED

This will record individual or programmed tracks at half speed. The converted recording will play one octave lower which provides a powerful new tool for difficult music transcription.

Because this is a tool and not a production process consider using a CD-RW disc that can later be erased. The disc must be finalized in order to be play on other CD drives.

SYNC RECORD

This REC mode is used to automatically engage the recording process from an outside digital or analog source including DAT, minidisk, cassette tape or LP for example.

The disc must be finalized in order to play on other CD drives.

SYNC RECORD+FINAL

Use this REC mode to automatically start the recording process from an outside digital or analog source including DAT, minidisk, cassette tape or LP for example.

The disc will automatically be finalized at the end of the recording session. The finalization takes approximately 2 minutes.

Recording tips

- Be sure to set the input, mix, and speaker switches to the appropriate setting prior to entering a record mode.
- Consider using a CD-RW (re-writable) disc. Then only the tracks that you like can be duplicated to a CD-R (write once) disc using the COPY 2X REC mode.
- To record MONO (one microphone or instrument to both channels of the CD recorder) switch the MIC/LINE SPLIT/STEREO/MIX switch to MIX.

How to Record continued

Recording tips continued:

- In order to avoid feedback during analog recording with any microphone, switch the SPEAKER to OFF or lower the level of the PHONE/SPEAKER LEVEL control. Lower the LINE OUT level control if you are connected to an external amplifier.
- Note the default conditions of AUTO TRACK and AUTO STOP outlined in this manual (see AUTO TRACK). Each recording mode has a default setup of these functions that can be altered to fit the conditions of your specific application.
- You can use the supplied infrared remote control to write your own track ID's during the recording process by pushing the TR INC button.
- When the remaining record time on the CD-R or CD-RW becomes 5 minutes, the message DISC END will be displayed, and then the display will indicate the remaining time both in minutes and seconds as well as graphically.
- When DISC FULL is displayed there is no more available recording time on the disc in the CDR drive.
- When DOES NOT FIT is displayed the amount of information you have selected to copy from the CD drive will not fit on the recording time available on the disc in the CDR drive.

Record adjustments

AUTO TRACK and AUTO STOP defaults

The default settings for AUTO TRACK and AUTO STOP depend on the REC mode.

REC mode	AUTO TRACK	AUTO STOP
REC with CD	OFF	OFF
RECORD	OFF	OFF
COPY+ LISTEN	ON	OFF
COPY 2X	ON	OFF
COPY 2X +FINAL	ON	OFF
CONV HALFSPEED	ON	OFF
SYNC RECORD	OFF	OFF
SYNC RECORD+FINAL	OFF	OFF

AUTO TRACK

When recording with AUTO TRACK ON the PSD300 will automatically increment tracks.

If AUTO TRACK is ON and the source of recording is a digital source that has tracks, such as a CD in the CD drive or a source input via the DIGITAL IN jack (CD/MD), those tracks will be included in your recording. This source data is usually found only in an SPDIF format digital connection.

If AUTO TRACK is ON and the source is digital (without track data) or analog, the PSD300 will use a silence gap to mark a track. When the source audio signal drops below -80dB for digital, or -40dB for analog, for 3 seconds or more and then rises to above those levels, the PSD300 will mark a new track and continue recording.

You can manually introduce a new track when AUTO TRACK is ON or OFF by pushing TR INC on the remote.

How to turn AUTO TRACK ON or OFF

- 1 With the PSD300 in one of the REC modes.
- 2 Push and release MENU/STORE.
- 3 Turn the SELECT control so AUTO TRACK is displayed.

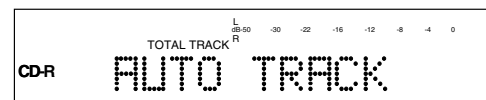

- 4 Push and release the SELECT control to select the AUTO TRACK menu item. The current status of AUTO TRACK ON or OFF is displayed.

Example shows AUTO TRACK ON.

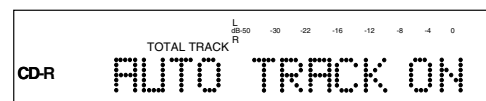

- 5 Push and release the SELECT control to select the displayed state of AUTO TRACK, or turn the SELECT control to select the other state and then push and release the SELECT control.
- 6 The display returns to AUTO TRACK.

How to Record continued

AUTO STOP

When recording with AUTO STOP ON the PSD300 will automatically stop after a period of silence. The silence will be recorded onto the last track of the recording session.

When recording with AUTO STOP ON from an analog source, the recording will stop after recording 20 seconds of silence (a signal lower than -40dB). When recording with AUTO STOP ON from a digital source (without track and stop data), the recording will stop after recording 4 seconds of silence (a signal lower than -80dB).

When recording in COPY + LISTEN, COPY 2X, or CONV HALFSPEED modes the recording will stop after detecting the stop data from the disc in the CD drive.

How to turn AUTO STOP ON or OFF

- 1 With the PSD300 in one of the REC modes
- 2 Push and release MENU/STORE.
- 3 Check or turn the SELECT control so AUTO STOP is displayed.

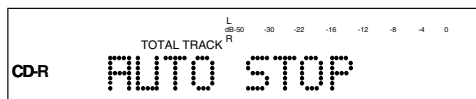

- 4 Push and release the SELECT control to select the AUTO STOP menu item. The current status of AUTO STOP ON or OFF is displayed.

Example shows AUTO STOP ON.

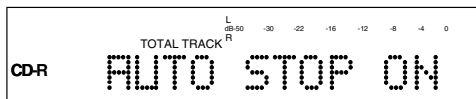

- 5 Push and release the SELECT control to select the displayed state of AUTO STOP, or turn the SELECT control to select the other state and then push and release the SELECT control.

- 6 The display returns to AUTO STOP.

How to adjust the MIC EQUALIZER

With the PSD300 in Stop, Play/Pause, REC or REC Pause mode.

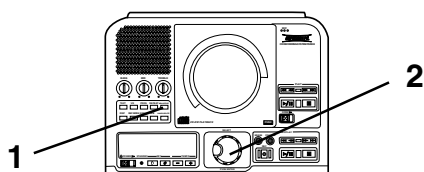

- 1 Push and release MENU/STORE.
- 2 Turn the SELECT control so MIC EQUALIZER is displayed.

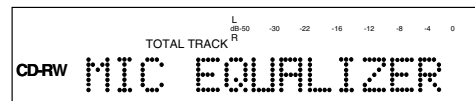

- a Push and release the SELECT control. MIC/LINE Rch is displayed.

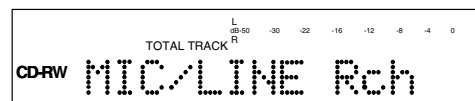

- b Push and release the SELECT control to confirm the right channel or turn the SELECT control to select the left channel. Then push and release the SELECT control to confirm.

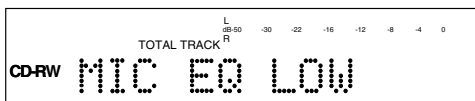

- c Push and release the SELECT control to confirm adjusting the low frequencies or turn the SELECT control to select adjusting the high frequencies. Then push and release the SELECT control to confirm.

Example display.

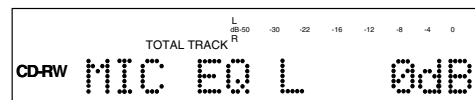

- d Turn the SELECT control to change the decibel level from -10 to +10 dB. Then push and release the SELECT control to enter the value and return to MIC EQUALIZER.

Repeat steps a, b, c and d to change the values for the other channel and High or Low.

When done push and release MENU/STORE to exit.

REC LEVEL

In all recording modes, when at record Pause, (REC button flashing) you can adjust the final record level by turning the SELECT control.

Example display.

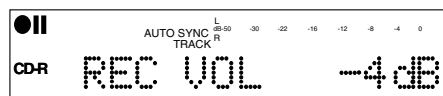

When ALC is set to ON, the REC LEVEL is not available in certain REC modes.

Record adjustments continued

How to adjust SPLIT BALANCE

The SPLIT BALANCE menu item lets you adjust the right left stereo balance from the CD drive.

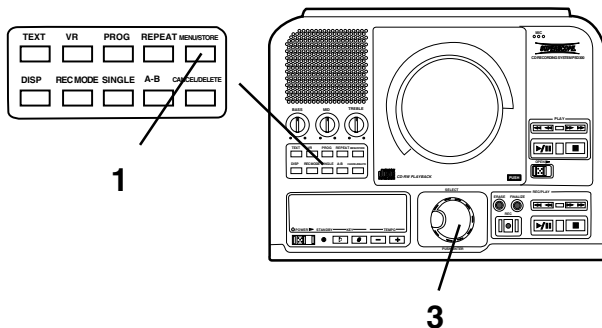

With the PSD300 in Stop, Play/Pause, REC or REC Pause mode,

- 1 Push and release MENU/STORE.
- 2 Turn the SELECT control so SPLIT BALANCE is displayed.

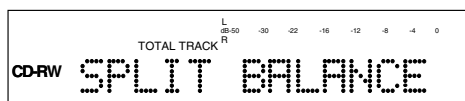

- a Push and release the SELECT control. The current balance setting is displayed

Example display shows mid point of balance.

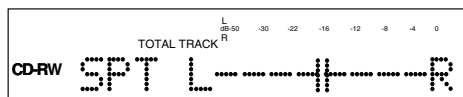

- b Turn the SELECT control clockwise to adjust balance to the Right and counter clockwise to adjust balance to the Left.

Example display shows balance to the Right.

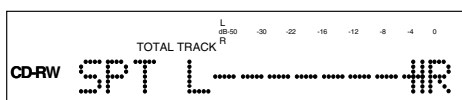

- c Push and release the SELECT control to confirm your balance adjustment. The SPLIT BALANCE display returns.
- d Push and release MENU/STORE to exit Menu mode.

How to adjust REC BALANCE

The REC BALANCE menu item lets you adjust the right left stereo balance for recording on the CDR drive. You can adjust REC BALANCE during a recording session by pausing the recording session.

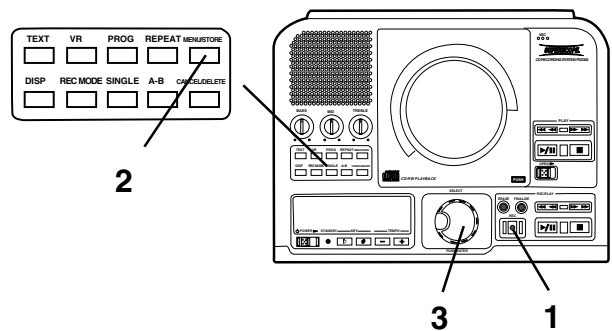

- 1 With the PSD300 in REC mode (recording mode selected and REC button lit and flashing).
- 2 Push and release MENU/STORE.
- 3 Turn the SELECT control so REC BALANCE is displayed.



- a Push and release the SELECT control. The current balance setting is displayed

Example display shows mid point of balance.

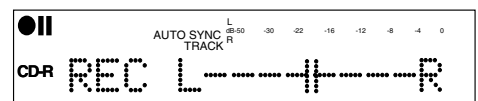

- b Turn the SELECT control clockwise to adjust balance to the Right and counter clockwise to adjust balance to the Left.

Example display shows balance partially to the Left.

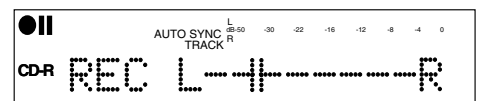

- c Push and release the SELECT control to confirm your balance adjustment. The REC BALANCE display returns.
- d Push and release MENU/STORE to exit Menu mode.

Record adjustments continued

How to select filters (FILTER SELECT)

The FILTER SELECT menu item lets you turn high pass or band pass filters on the right or left MIC/LINE inputs on or off.

Frequency	FILTER SPECIFICATIONS		
	BAND PASS OFF	BAND PASS ON	HIGH PASS ON
20Hz	0dB	-48dB	-48dB
50Hz	0dB	-24dB	-24dB
100Hz	0dB	-6dB	-12dB
250Hz	0dB	0dB	0dB
500Hz	0dB	0dB	0dB
1kHz	0dB	0dB	0dB
5kHz	0dB	0dB	0dB
10kHz	0dB	-6dB	0dB
15kHz	0dB	-12dB	0dB
20kHz	0dB	-24dB	0dB

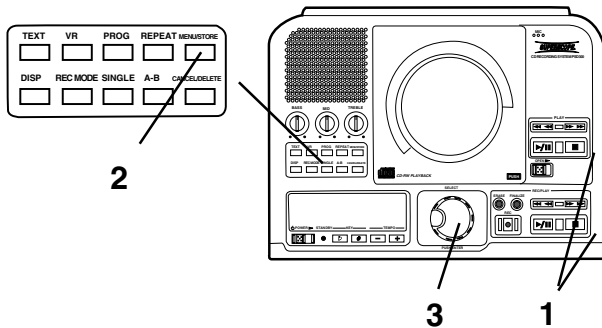

- 1 With the PSD300 in Stop, Play/Pause, REC or REC Pause mode,
- 2 Push and release MENU/STORE.
- 3 Turn the SELECT control so FILTER SELECT is displayed.

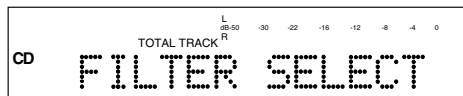

- a Push and release the SELECT control. MIC/LINE Lch or MIC/LINE Rch is displayed

Example display.

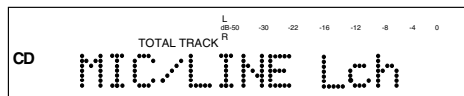

- b Turn the SELECT control to switch between Lch (left channel) and Rch (right channel). Push and release the SELECT control to confirm your selection. The display switches to one of three filter choices (BAND PASS ON, HIGH PASS ON, or FILTER OFF).

Example display.

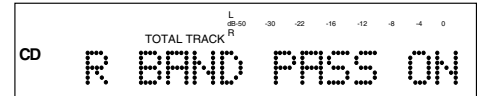

- c Push and release the SELECT control to confirm the displayed filter selection or turn the SELECT control to switch to the other choices.

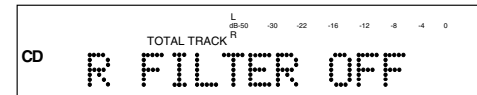
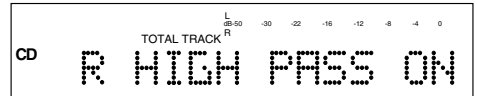

- d When you have confirmed your selection the display returns to FILTER SELECT.

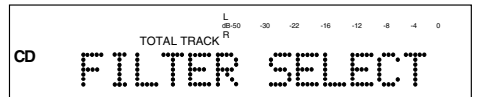

When done making filter selections push and release MENU/STORE (2) to exit Menu mode.

How to Erase

You can only erase CD-RW discs.

You can erase one or more tracks from the end of the CD-RW disc, or you can erase the entire disc. If finalized, erasing a track or the disc automatically unfinalizes the disc.

Push and release ERASE

- **Once** to select erasing the last track of the disc,
- **Twice** in succession to erase the entire disc,
- **Three** times in succession to unfinalize.

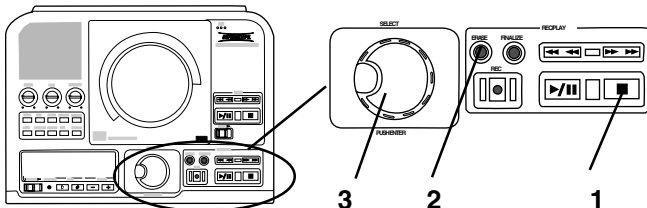

After the second push ERASE DISC is displayed for about three seconds.

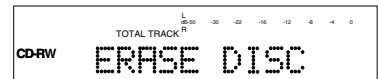

Then PUSH ENTER is displayed.



3 Push the SELECT PUSH/ENTER control. The timer (a) counts down as the disc is erased.

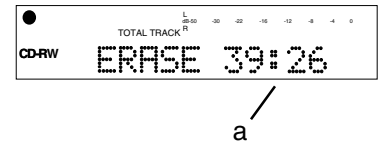

When done the display shows BLANK DISC.

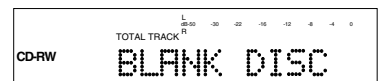

How to Erase the last track

1 Push Stop. The display shows the number of tracks and their total playing time (example shown).



2 Push ERASE. ERASE TRACK is displayed for about 3 seconds.

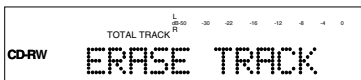

Then PUSH ENTER is displayed.

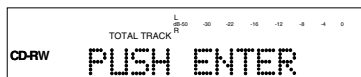

3 Push the SELECT PUSH/ENTER control. The timer (a) counts down as the track is erased.

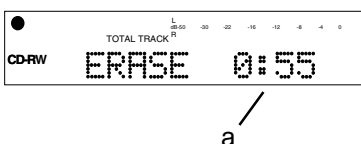

When done the display shows the remaining number of tracks and their total playing time (example shown).

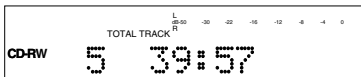

How to Erase the entire disc

1 Push Stop. The display shows the number of tracks and their total playing time (example shown).

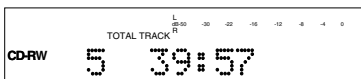

2 Push ERASE twice. After the first push ERASE TRACK is displayed.

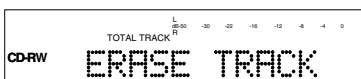

How to Finalize

Finalizing is writing the TOC (table of contents) on a disc so a CD player can recognize the number of tracks, the total time for each track, and their location on the disc. A recorded disc must be finalized to playback on a standard CD player. Once finalized a CD-R disc can be played on CD players that support CD-R playback. CD-RW discs can only be played on CD players that support CD-RW playback. Consult your CD player owner's manual to confirm supported formats.

Finalizing is necessary to:

- be able to play a recorded CD-R or CD-RW disc on a CD player including the PSD300 CD drive
- prevent further recording on a disc
- avoid erasing tracks on a CD-RW disc
- record text information onto a disc you record

Notes:

- A finalized CD-R disc can never be recorded onto again.
- A finalized CD-RW disc can be unfinalized for more recording.
- The PSD300 can play back unfinalized CD-R or CD-RW discs in the CDR drive.
- Several recording modes automatically finalize: COPY 2X+FINAL, and SYNC RECORD+FINAL.

How to Finalize continued

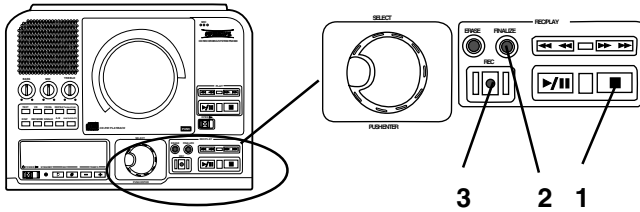

How to Finalize a CD-R or CD-RW disc:

1 Push Stop on the CDR drive.

The display shows the number of tracks and their total playing time (example shown).



2 Push FINALIZE. FINALIZE is displayed for about 3 seconds.



Note:

If the disc is blank or has already been finalized, NOT POSSIBLE flashes twice, then the previous display returns.

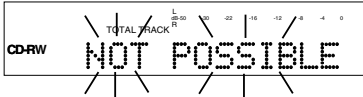

Then PUSH REC KEY is displayed.

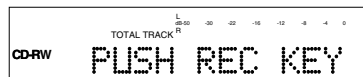

3 Push the REC button. The timer (a) counts down as the track is erased.

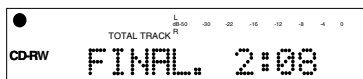

When done the display shows the number of tracks and their total playing time (example shown).

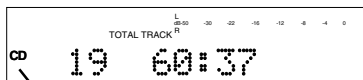

CD-RW or CD-R changes to CD (b).

How to Unfinalize a CD-RW disc

1 Push Stop on the CDR drive. The display shows the number of tracks and their total playing time (example shown).



2 Push ERASE three times. After the first push ERASE TRACK is displayed.

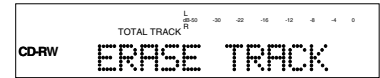

After the second push ERASE DISC is displayed.

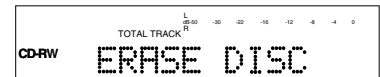

After the third push UNFINALIZE is displayed for about three seconds.



Then PUSH ENTER is displayed.

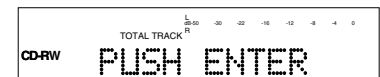

3 Push the SELECT PUSH/ENTER control. The timer (a) counts down as the finalizing is erased.

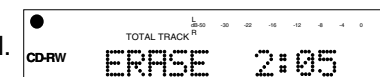

When done the display shows the number of tracks and their total playing time (example shown).

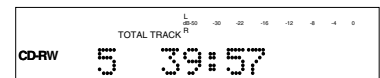

The disc has been unfinalized but not erased.

About the Remote

The supplied infrared remote control permits most functions of the PSD300 to be controlled remotely.

See **Remote batteries** for installing or changing remote batteries.

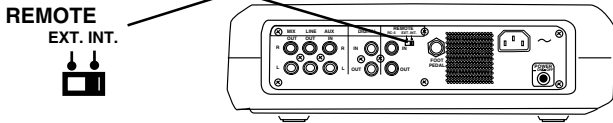

The REMOTE EXT. INT. switch on the back of the PSD300 must be at INT. for the infrared remote to work.

Most of the controls on the remote work identically to the control on the unit. The page number describing identical functioning unit controls is given below.

Further instruction is supplied for controls that are on the remote only or that function differently from controls on the unit.

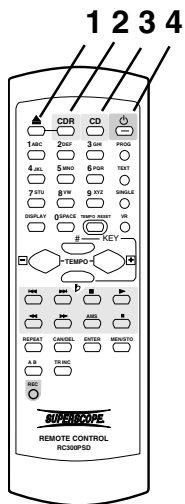

1 = OPEN/CLOSE switch for the CDR drive.
See page 16.

2 CDR select button. Push to select the CDR drive.
When selected buttons on this remote such as Play, Pause, Stop, and Search work on the CDR drive rather than CD playback.

3 CD select button. Push to select the CD drive.

When selected buttons on this remote such as Play, Pause, Stop, and Search work on the CD drive rather than the CDR drive.

4 = Standby POWER switch.
See page 11.

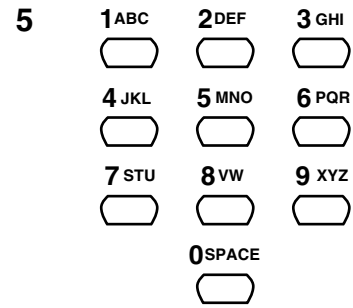
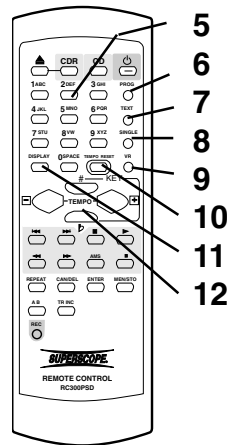

Alphanumeric keypad

Performs some of the functions of the SELECT control.

In Play and Program modes push and release a number button to select the track. Then push ENTER on the unit or remote to enter the selection. When entering CD TEXT push a number button once to select the first of the three letters, twice for the second and three times for the third. Push ENTER on the remote or unit to enter the selected number.

6 = PROG button. See page 7.

7 = TEXT button. See page 7.

8 = SINGLE button. See page 10.

9 = VR button. See page 7.

10 **TEMPO RESET button**
On the PSD300 resetting the Tempo to 0% (normal speed) is done by pressing both Tempo controls at the same time. The TEMPO RESET button is the same as pushing both Tempo controls at the same time.
See page 12.

11 = DISP button. See page 9.

12 = Tempo controls except for TEMPO RESET above.

See page 12.

About the Remote continued

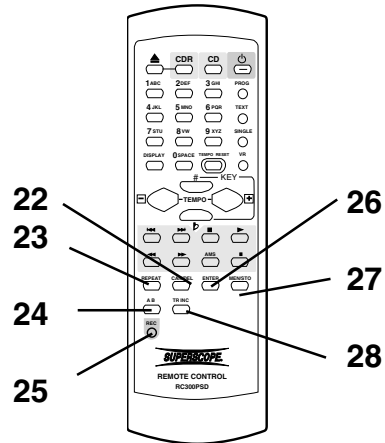
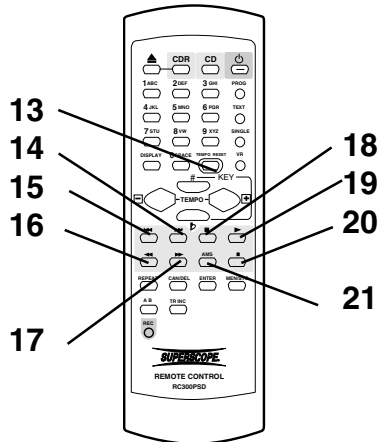

13 # KEY = KEY controls.
See page 11.

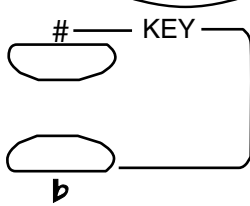

22 CAN/DEL = CANCEL DELETE button.
See page 10.

23 REPEAT = REPEAT button.
See page 7.

24 A B = A-B button.
See page 10.

25 REC = REC button.
See page 14.

14 Track Skip forward button.
Push and release during Play or Pause to skip forward to the next track.

15 Track Skip backward button.
Push and release during Play or Pause to skip backward to the previous track.

16 = Fast backward search button.
See page 11.

17 = Fast forward search button.
See page 11.

18 = Stop button.
See page 11.

19 = Play of Play/Pause button.
See page 11.

20 = Pause of Play/Pause button.
See page 11.

21 AMS (Automatic Search) button.
Remote only. Push and release to play the first 10 seconds of each track. AMS

is displayed in the time display while searching. Push Pause to pause the automatic search. Push Play to switch from AMS to Play. Automatically stops at the end of the disc. Push AMS to exit automatic search.

26 ENTER ENTER button.
Performs some of the functions of the SELECT control.

- In Play and Program modes push number button to select the track. Then push ENTER to enter the selection.
- Selects settings in MENU mode.
- Programs track numbers.
- Enters a letter during finalizing text entry.
- When entering CD TEXT push ENTER to enter the selected character.

27 MEN/STO = MENU/STORE button.
See page 8.

28 TR INC TR INC button. Remote only.
During recording push and release to manually increment a new track. It is recommended to set AUTO TRACK to OFF.

About CD discs

The PSD300 can play CD, CD-R, or CD-RW discs and can record on CD-R or CD-RW discs:

CD-R (record once)

CD-R discs are only able to be recorded onto a single time but will playback in most CD players.

CD-R discs can be recognized by the following logos:



CD-RW (multiple recording)

CD-RW discs are able to be recorded onto many times but will only playback in CD players offering CD-RW compatibility. Products that offer CD-RW compatibility are available from Marantz, Marantz Professional, and Superscope. Please contact your dealer for more information on these products.

CD-RW discs can be recognized by the following logos:



Notes:

- Most DVD players cannot playback CD-R discs and some cannot playback CD-RW discs because of laser power differences.
- Some CD players may be able to playback finalized CD-RW discs.
- Some CD players can not play finalized CD-R discs because of the low reflectivity of such discs.

Which discs to use:

The PSD300 is able to record onto any 1X or 2X compatible CD-R and CD-RW disc, including discs for Consumer use and Professional (computer) discs.

The PSD300 records according to the Orange Book specification. Every CDR disc sold should be according to the Orange Book specification and therefore compatible with the PSD300.

In practice however, the quality of the recording depends on the match between the disc used and the writing strategy of the recorder. At 1X speed (stand alone audio) the match between disc and recorder is

important. Higher recording speeds are less critical in terms of recording quality.

Consumer CD Recorders can only record on CDR Audio discs and those discs are optimized for single speed automatically. Professional CD Recorders can use both Audio and Data discs. When using Data discs, one should take care to use discs with a good single speed compatibility.

Recording Capacity:

Discs with higher capacity than 74 minutes (80 minutes) are out of the Orange Book standard and may perform below your expectations.

Compact disc care

The glossy side is the record side of the disc, and matted (dull) side is the label side.

Handle discs carefully so as not to damage or scratch the record side.

Avoid placing discs in the following locations:

- In direct sunlight or near a source of heat such as a heater.
- In a place that is damp or dirty.
- In a place which could be exposed to rain, such as near a window.

Disc cleaning

Always keep the disc surface clean. Up to six billion data units are recorded on the record side of the disc. When cleaning the disc surface always be sure to use a special compact disc cleaner and wipe as shown below.

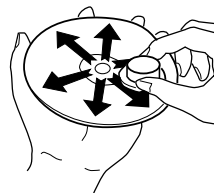

Wipe in a radial direction.

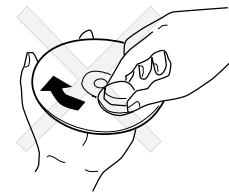

Do not wipe in circumferential direction.

- Do not use record cleaner, it will adversely affect the disc surface.
- Store discs in their disc cases.
- Do not attach a piece of paper or sticker to the label side of the disc. When a disc has a piece of plastic

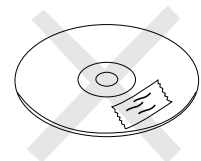

tape or rental CD label with paste protruding from the edge or when a disc has a trace of such as sticky object, do not attempt to play the disc. The disc may be impossible to take out, or another malfunction may result.

- Write only on the printed side of a CD-R or CD-RW disc, and only with a soft felt-tipped pen.
- Do not attempt to record a disc with a special shape.
- Do not attempt to play a disc with a special shape such as an octagonal or heart shaped disc. Equipment malfunction may result.



CD text

CD text, when present, provides text information such as the CD title, artist, track titles, and track artists.

The PSD300 can record text information on an unfinalized CD-R or CD-RW that you record.

CD text during playback

When a disc is inserted in the CD drive or CDR drive the PSD300 automatically detects if a disc has text information and automatically displays the CD title. The PSD300 can display 14 characters, if the text information is longer than that the text automatically scrolls from right to left.

Play

The following information, if available, is displayed every time the TEXT button is pushed and released while the PSD300 is playing. During Stop the track information is unavailable.

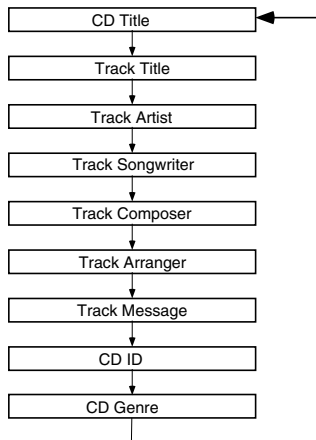

Recording CD text

Before finalization of a CD you can enter text information. Only the CD title and track titles can be entered.

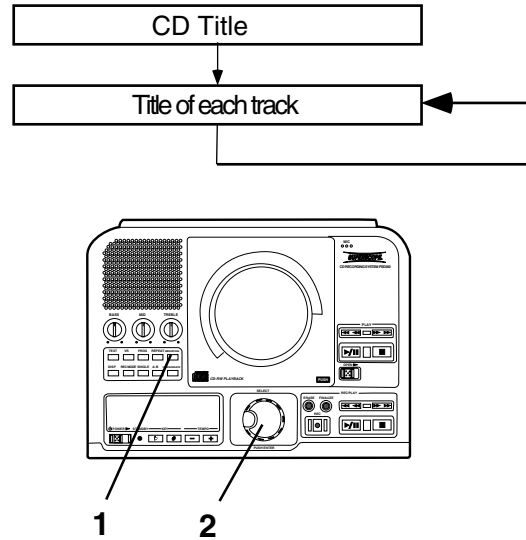

With your unfinalized disc in the CDR drive and stopped

- 1 push and release Menu/Store.
- 2 Turn the SELECT control so TEXT EDIT is displayed.

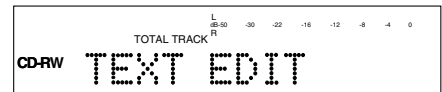

Push and release the SELECT control to select. CD TITLE is displayed.

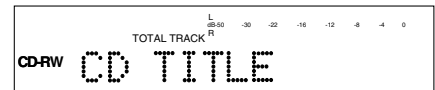

(Turn the SELECT control to select editing track titles.) Push and release the SELECT control to select editing the CD TITLE or the Track title. The first character of the title is flashing.

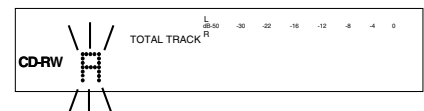

Turn the SELECT control to select the character. Or from the remote with CDR selected, push and release alphanumeric keys to select the character.

Recording CD text continued

The SELECT control presents the following characters in order:

```

ABCDEFGHIJKLMNPO
QRSTUVWXYZ
abcdefghijklmnop
9hijklnop
qrstuvwxyz
0123456789 _
!"#$%&'()*+,-./:;
<=>?@[\]^_`{|}~
    
```

The _ after the 9 is displayed as a space.

Consider using the infrared remote control to enter CD text. All the numbers, the space, and all upper and lower case characters are available from the remote alphanumeric keypad.

When the correct character is flashing, push and release the SELECT control or push ENTER on the remote.

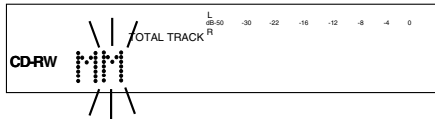

In this example M was entered. The entered character is repeated and flashing.

Continue selecting characters and entering them. Up to 23 characters.

The Fast backward search button and Fast forward search button both work as the cursor during text editing. Push and release to move the editing position one character.

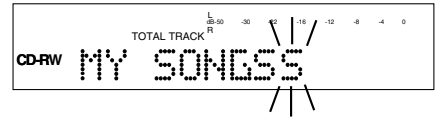
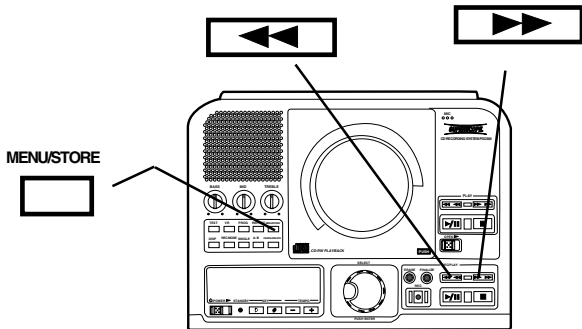

After the final character is entered, push and release MENU/STORE.

Note: All CD text entries are in short term memory until the CD is finalized. You can play, pause and stop, but if you turn off power, or open the CDR drive your editing will be lost.

How to view CD text

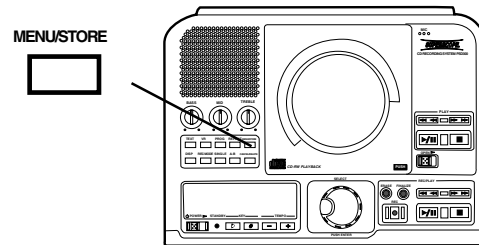

The TEXT VIEW menu item lets you review the CD text that has been entered before a disc is finalized.

With your disk in the CDR drive and stopped

- 1 Push and release MENU/STORE.
- 2 Turn the SELECT control so TEXT VIEW is displayed.

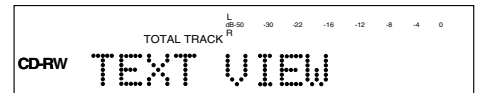

- 3 Push and release the SELECT control to confirm the selection.

Example display

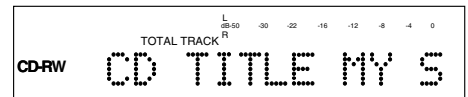

- 4 Push and release the SELECT control to review how the album title scrolls by when displayed, or,
- 5 Turn the SELECT control to switch to reviewing track text.

Example display

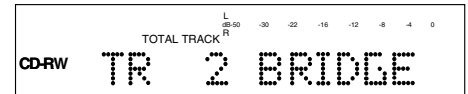

How to erase CD text

The TEXT ERASE menu item lets you delete CD text that has been entered.

With your unfinalized disk in the CDR drive and stopped

- 1 Push and release MENU/STORE.
- 2 Turn the SELECT control so TEXT ERASE is displayed.

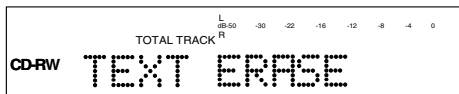

- 3 Push and release the SELECT control to confirm the selection. ALL TEXT is displayed.

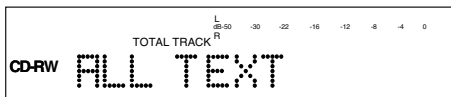

When ALL TEXT is displayed, turn the SELECT control to select erasing only the CD title or a track title.

- 4 Push and release the SELECT control to confirm the selection. ERASE? is displayed briefly, then PUSH ENTER is displayed.

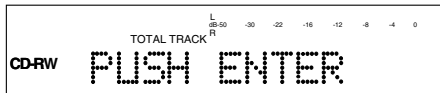
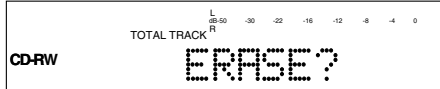

Push and release the SELECT control to erase the selected text.

RC-5 remote control codes

Function	CD code		CD-R code	
	System (dec)	Command (dec)	System (dec)	Command (dec)
0 _ Space	20	00	26	00
1 ABCabc	20	01	26	01
2 DEFdef	20	02	26	02
3 GHIghi	20	03	26	03
4 JKLjkl	20	04	26	04
5 MNOmno	20	05	26	05
6 PQRpqr	20	06	26	06
7 STUstu	20	07	26	07
8 VWvw	20	08	26	08
9 XYZxyz	20	09	26	09
PLAY	20	53	26	53
STOP	20	54	26	54
PAUSE	20	48	26	48
NEXT	20	32	26	32
PREVIOUS	20	33	26	33
FF	20	52	26	52
REW	20	50	26	50
PROGRAM	20	36	-	-
CANCEL/DELETE	20	49	26	49
DISPLAY	20	11	26	11
TEMPO +	20	38	-	-
TEMPO -	20	39	-	-
KEY +	20	68	-	-
KEY -	20	69	-	-
AMS (intro scan)	20	43	-	-
TEMPO RESET	20	37	-	-
REC	-	-	26	55
OPEN/CLOSE	26	45	26	45
STANDBY	20	12	26	12
TEXT	20	15	26	15
ENTER	20	87	26	87
MENU/STORE	20	82	26	82
REPEAT	20	29	26	29
A - B	20	59	-	-
CD	20	63	-	-
CD-R	-	-	26	63
TR.INCR	-	-	26	114
SINGLE	20	59-11	-	-
VR voice reduction	20	67	-	-

Troubleshooting

Warning!

Under no circumstances should you try to repair the unit yourself. That will cause a safety hazard and void the warranty.

No Power

- Check that the Power switch on the back of the PSD300 is in the in ON position.
- If the STANDBY light is lit, slide the POWER switch to the right.
- Check that the power cord is plugged in correctly.
- Switch the Power switch on the back of the unit OFF and then back ON.

No sound

- Check audio connections.
- Check position of level control (LINE OUT for attached amplifier speaker system, PHONE/SPEAKER LEVEL for internal speaker or headphones).

Amplified sound is distorted

- Check that LINE OUT is not connected to a Phono input.
- Check that the disc is not defective (try another disc.)

Disc problems

Display message	Description
DATA/DISC ERROR.....	Disc is not an audio CD.
DISC ERROR	Corrupt or out of specifications disc.
OPC ERROR	Optimum Power Calibration (OPC) failure. Disc problem, use new disc.
REC ERROR	Recording interrupted as a result of transport failure due to shock or a bad sector of the recordable disc.

Maintenance

- Clean the PSD300 with a soft, slightly dampened lint-free cloth. Do not use any cleaning agents as they may have a corrosive effect.
- Do not expose the PSD300, batteries or CDs to humidity, rain, sand or excessive heat (caused by heating equipment or direct sunlight).
- The lenses may cloud over when the PSD300 is suddenly moved from cold to warm surroundings. It is not possible to play a CD then. Leave the PSD300 in a warm environment until the moisture evaporates.
- Always keep the tray closed to avoid dust on the lens.

Play will not start

- Check that the disc is inserted correctly.
- Check that the disc is not defective (try another disc.)
- Check that the disc is finalized (CD drive only).

Remote control does not work

- Check that the REMOTE EXT./INT. switch is at INT.
- Select the right source (CD or CDR).
- Point the infrared remote at the remote sensor.
- Check/replace batteries.

Recording is distorted

- Check/lower recording level.
- Check for a defective disc by trying another disc.

Will not record

- Check/clean the disc.
- Check that the disc is recordable.
- Check that the right input source is selected.
- Check that the disc is not defective. Clean the disc or try another disc.

Specifications

General

System	Compact Disc Digital Audio (CD-DA)
Number of channels	2 (stereo)
Applicable discs	CD, CD-R, CD-RW
Power requirement	AC 120V 60 Hz, 21W
Dimensions (maximum)	
Width	11 inches (279 mm)
Height	4 inches (102 mm)
Depth	9 inches (229 mm)
Weight	7 pounds (3.2 Kg)

Audio

ADC	24 Bit Resolution 64x oversampling
DAC	16 Bit Resolution 8x oversampling
Overall frequency response	20 Hz - 20 kHz

CD-R drive output

Playback S/N	85 dB
Playback Dynamic Range	85 dB
Playback Total Harmonic Distortion	0.05%
Output Voltage/Impedance (Line Output)	1.0 V/2K

CD drive output

Playback S/N	75 dB
Playback Dynamic Range	75 dB
Playback Total Harmonic Distortion	0.1%
Output Voltage	1.0V/2K

MIC/LINE analog input

LINE level	
S/N	80 dB
THD	0.05%
Input Sensitivity/Impedance	500 mV/2K
MIC level	
S/N	60 dB
THD	0.2%
Input Sensitivity/Impedance	1.2 mV/2K

AUX analog input

S/N	75 dB
THD	0.05%
Input Sensitivity/Impedance	800 mV/23K

Digital Input

Sample rate	11 kHz ~ 58 kHz
-------------------	-----------------

Digital Output

Output Level/Impedance	0.5 Vp-p/75 ohm
------------------------------	-----------------

Headphone Output (10% THD)

Level/Impedance	70 mW/32 ohm
-----------------------	--------------

Speaker Output (10% THD)

Level/Impedance	1.7 W/8 ohm
-----------------------	-------------

WARRANTY

One Year Limited Warranty:

Your Superscope PSD300 is warranted against manufacturer defects in material and workmanship for one year parts and labor.

Non-transferable warranty:

This warranty may be enforced only by the original purchaser.

The following are not covered under warranty:

1. Damage, deterioration, malfunction or failure to meet performance specifications resulting from:
 - accident, acts of nature, misuse, abuse, neglect or unauthorized product modification.
 - improper installation, removal or maintenance, or failure to follow supplied instructions.
 - repair or attempted repair by a non-Superscope authorized agent.
 - any shipment (claims must be presented to the carrier).
 - any cause other than a defect of manufacturing.
2. Cleaning, check-ups with no fault found.
3. Any product on which the serial number has been defaced, modified or removed.
4. Accessories, including but not limited to, cables and adaptors.
5. Product purchased outside of the United States, its possessions or territories.

The following are covered under warranty:

All labor and material expenses for items covered by the warranty.

To obtain service:

1. If your unit needs service contact Superscope at (630) 820-4800. A service representative will advise you of how to obtain service. Please do not return the unit directly to Superscope Technologies, unless specified by our service representative.
2. You must pay any shipping charges if it is necessary to ship the product for service. If the necessary repairs are covered by the warranty, we will pay return shipping charges to your location anywhere in the United States.
3. Whenever warranty service is required, you must present the original dated sales receipt, or other proof of purchase.

Limitation of implied warranties

All implied warranties, including warranties of merchantability and fitness for a particular purpose, are limited in duration to the length of this warranty.

Exclusion of damages

Liability for any defective product is limited to repair or replacement of the product at Superscope's option. Superscope shall not be liable for damage to other products caused by any defects in Superscope products, damages based on inconvenience or loss of use of the product, or any other damages, whether incidental, consequential, or otherwise.

Some States do not allow limitations on how long an implied warranty lasts and/or do not allow the exclusion or limitation of incidental or consequential damages, so the above limitations and exclusions may not apply to you.

How State law relates to the warranty

This warranty gives you specific legal rights, and you may have other rights which may vary from State to State.

This warranty is enforceable only in the United States and its possessions or territories.

The logo for Superscope Technologies, featuring the word "SUPERSCOPE" in a bold, italicized, sans-serif font. The text is centered between two thick, curved horizontal lines that sweep upwards from the left and downwards from the right, creating a stylized, dynamic shape.

SUPERSCOPE®

Superscope Technologies, Inc. 1508 Batavia Ave. Telephone (630) 232-8900
Geneva, Illinois 60134 Fax: (630) 232-8905
Internet: www.superscopetechnologies.com